



LITEMAX

ULF/ULH1563-K
15.6" LED B/L LCD

User Manual

Approved by	Checked by	Prepared by

LITEMAX Electronics Inc.
8F, No.137, Lane 235, Bau-chiau Rd.,
Shin-dian Dist., New Taipei City, Taiwan
R.O.C.
Tel : 886-2-8919-1858
Fax: 886-2-8919-1300
Homepage: <http://www.litemax.com>

Record of Revision

Version and Date	Page	Old Description	New Description	Remark
Sep/16/2025	all		Initial release	

Contents

Record of Revision	2
Contents	3
1 General Description	4
1.1 Key Features.....	4
1.2 General Specifications.....	4
1.3 Absolute Maximum Ratings.....	5
2 Electrical Specifications	6
2.1 Electrical Characteristics.....	6
2.2 Pin Assignment For Open Cell Connect	7
2.3 Input Signals, Basic Display Colors and Gray Scale of Colors	8
2.4 Signal Timing Specification	9
2.5 Power Sequence	10
3 Optical Specification	11
4 Electrical Characteristics	13
4.1 LED Driving Board Specifications	13
4.2 LED Driving Board Connector Pin Assignment	14
4.3 LED Driving Board Mechanical Characteristics.....	14
5 Mechanical Drawing	15
6 AD68862HP Board & OSD Functions	17
6.1 OSD Function.....	23
6.2 OSD Menu	24
7 Precautions	30
7.1 Handling and Mounting Precautions.....	30
7.2 Storage Precautions	30
7.3 Operation Precautions	31
8 Disclaimer	31

1 General Description

The **ULF/ULH1563-K** is a 15.6 inch industrial grade LCD, with brightness **500 nits**, it produces sharp images, crisp text and lifelike colors. The Ubipixel LED backlight technology ensures high reliability and low power consumption, suitable for outdoor application, kiosk, factory automation, military, transportation and gaming application.

1.1 Key Features

- Brightness 500nits
- Resolutions: 1920 x 1080
- LED Backlight
- Aspect ratio of 16:9
- Low power consumption
- BL MTBF: 30,000 hours

1.2 General Specifications

Model Name	ULF/ULH1563-K
Description	15.6" TFT LCD, 500 nits LED Backlight, 1920 x 1080
Screen Size	15.6"
Display Area (mm)	344.16(H) x 193.59(V)
Brightness	500 cd/m ²
Resolution	1920 x 1080
Aspect Ratio	16 : 9
Contrast Ratio	1100:1
Pixel Pitch (mm)	0.17925(H) x 0.17925 (V)
Pixel Per Inch (PPI)	141
Viewing Angle	170°(H),170°(V)
Color Saturation (NTSC)	82%
Display Colors	16.7M
Response Time (Typical)	30 ms
Panel Interface	eDP
Input Interface	HDMI, DP
Input Power	DC12V
Power Consumption	4.3W (7.3W with AD Control Board)
OSD Key	4 Keys (Power Switch, Menu, +, -)
OSD Control	Brightness, Color, Contrast, Auto Turing, H/V Position...etc
Dimensions (mm)	360.1 x 212.55 x 7.33
Bezel Size(U/B/L/R)	8.55/10.41/6.76/9.18
Weight (Net)	1.7 kg
Operating Temperature	0 °C ~ 50 °C
Storage Temperature	-20 °C ~ 60 °C

ULF= Panel + LED Driving Board

ULH= Panel + LED Driving Board + AD Control Board

1.3 Absolute Maximum Ratings

The followings are maximum values which, if exceed, may cause faulty operation or damage to the unit. The operational and non-operational maximum voltage and current values are listed in table.

Parameter	Symbol	Min.	Max.	Unit	Remark
Power Supply Voltage	VDD	-0.3	5.5	V	Ta = 25 °C
Operating Temperature	T _{OP}	0	+50	°C	Note 1
	T _{SUR}	-10	+60	°C	
Storage Temperature	T _{ST}	-20	+60	°C	
Operating Ambient Humidity	Hop	10	80	%RH	
Storage Humidity	Hst	10	80	%RH	

Note 1:

Temperature and relative humidity range are shown in the figure below. Wet bulb temperature should be 39 °C max. and no condensation of water.

T_{SUR}: Panel surface Temperature is measured at 50°C Dry Condition

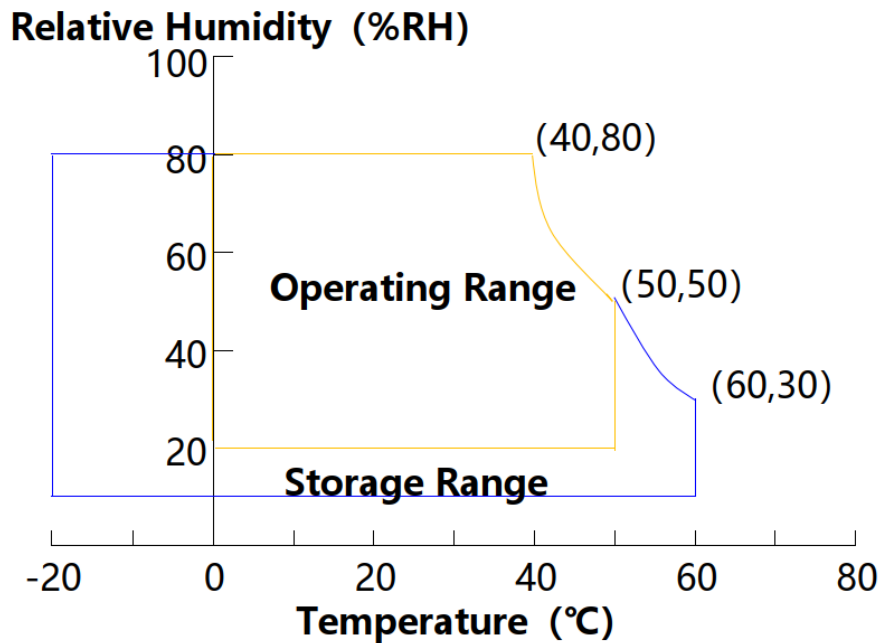

2 Electrical Specifications

2.1 Electrical Characteristics

TFT LCD Module

Parameter	Symbol	Values			Unit	Notes	
		Min.	Typ.	Max.			
Power Supply Voltage	VDD	2.7	3.3	5.0	V	Note 1	
Power Supply Ripple Voltage	VRP	-	-	300	mV		
Power Supply Current	IDD		300	700	mA		
Rush current	IRUSH	-	-	2	A	Note 2	
eDP Interface	Main link swing voltage	$ V_{ID} $	100	-	1000	mV	
	Common mode voltage	Vcm	0	-	2	V	
Power Consumption	P_D		1.08	2.1	W	Note 1	

Notes :

- The supply voltage is measured and specified at the interface connector of FOB. The current draw and power consumption specified is for 3.3V at 25 °C Max value at H 1 Line Pattern.
 - Typ: Mosaic Pattern
 - Max: H1L Pattern
- The duration of rush current is about 2ms and rising time of Power Input is 1ms(min).

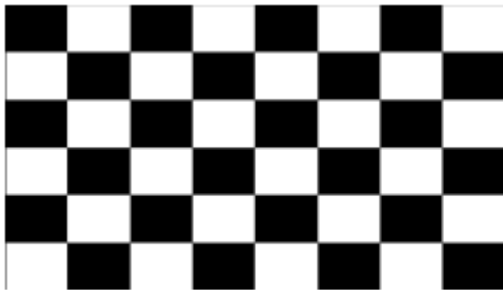

(a)

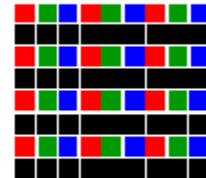

(b)

2.2 Pin Assignment For Open Cell Connect

- eDP Connector: MSAK24025P30 or Equivalent

PIN #	Symbol	Description Remark	PIN #	Symbol	Description Remark
1	NC	NC	16	H_GND	Ground
2	H_GND	Ground	17	HPD	Hot Plug Detect Output
3	LANE1_N	eDP RX Channel 1 Negative	18	BL_GND	LED Ground
4	LANE1_P	eDP RX Channel 1 Positive	19	BL_GND	LED Ground
5	H_GND	Ground	20	BL_GND	LED Ground
6	LANE0_N	eDP RX Channel 0 Negative	21	BL_GND	LED Ground
7	LANE0_P	eDP RX Channel 0 Positive	22	BL_ENABLE	LED Enable Pin(+3.3V Input)
8	H_GND	Ground	23	BL_PWM	System PWM Signal Input
9	AUX_CH_P	eDP AUX CH Positive	24	NC	No Connection
10	AUX_CH_N	eDP AUX CH Negative	25	NC	No Connection
11	H_GND	Ground	26	BL_POWER	LED Power Supply 10.8V-13.2V
12	LCD_VCC	Power Supply, 3.3V (typ.)	27	BL_POWER	LED Power Supply 10.8V-13.2V
13	LCD_VCC	Power Supply, 3.3V (typ.)	28	BL_POWER	LED Power Supply 10.8V-13.2V
14	BIST	Panel Self Test Enable	29	BL_POWER	LED Power Supply 10.8V-13.2V
15	H_GND	Ground	30	NC	No Connection

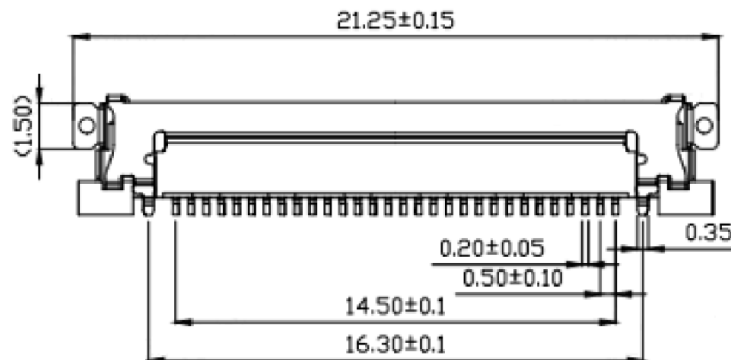

2.3 Input Signals, Basic Display Colors and Gray Scale of Colors

Color & Gray Scale		Input Data Signal																							
		Red Data								Green Data						Blue Data									
		R7	R6	R5	R4	R3	R2	R1	R0	G7	G6	G5	G4	G3	G2	G1	G0	B7	B6	B5	B4	B3	B2	B1	B0
Basic Colors	Black	0	0	0	0	0	0	0	0	0	0	0	0	0	0	0	0	0	0	0	0	0	0	0	0
	Blue	0	0	0	0	0	0	0	0	0	0	0	0	0	0	0	0	1	1	1	1	1	1	1	1
	Green	0	0	0	0	0	0	0	0	1	1	1	1	1	1	1	1	0	0	0	0	0	0	0	0
	Cyan	0	0	0	0	0	0	0	0	1	1	1	1	1	1	1	1	1	1	1	1	1	1	1	1
	Red	1	1	1	1	1	1	1	1	0	0	0	0	0	0	0	0	0	0	0	0	0	0	0	0
	Magenta	1	1	1	1	1	1	1	1	0	0	0	0	0	0	0	0	1	1	1	1	1	1	1	1
	Yellow	1	1	1	1	1	1	1	1	1	1	1	1	1	1	1	1	0	0	0	0	0	0	0	0
	White	1	1	1	1	1	1	1	1	1	1	1	1	1	1	1	1	1	1	1	1	1	1	1	1
Gray Scale of Red	Black	0	0	0	0	0	0	0	0	0	0	0	0	0	0	0	0	0	0	0	0	0	0	0	
	Δ	0	0	0	0	0	0	0	1	0	0	0	0	0	0	0	0	0	0	0	0	0	0	0	
	Darker	0	0	0	0	0	0	1	0	0	0	0	0	0	0	0	0	0	0	0	0	0	0	0	
	Δ																								
	▽																								
	Brighter	1	1	1	1	1	1	0	1	0	0	0	0	0	0	0	0	0	0	0	0	0	0	0	
	▽	1	1	1	1	1	1	0	0	0	0	0	0	0	0	0	0	0	0	0	0	0	0	0	
	Red	1	1	1	1	1	1	1	1	0	0	0	0	0	0	0	0	0	0	0	0	0	0	0	0
Gray Scale of Green	Black	0	0	0	0	0	0	0	0	0	0	0	0	0	0	0	0	0	0	0	0	0	0	0	
	Δ	0	0	0	0	0	0	0	0	0	0	0	0	0	0	0	1	0	0	0	0	0	0	0	
	Darker	0	0	0	0	0	0	0	0	0	0	0	0	0	0	1	0	0	0	0	0	0	0	0	
	Δ																								
	▽																								
	Brighter	0	0	0	0	0	0	0	0	1	1	1	1	1	1	0	1	0	0	0	0	0	0	0	
	▽	0	0	0	0	0	0	0	0	1	1	1	1	1	1	0	0	0	0	0	0	0	0	0	
	Green	0	0	0	0	0	0	0	0	1	1	1	1	1	1	1	0	0	0	0	0	0	0	0	
Gray Scale of Blue	Black	0	0	0	0	0	0	0	0	0	0	0	0	0	0	0	0	0	0	0	0	0	0	0	
	Δ	0	0	0	0	0	0	0	0	0	0	0	0	0	0	0	0	0	0	0	0	0	0	1	
	Darker	0	0	0	0	0	0	0	0	0	0	0	0	0	0	0	0	0	0	0	0	0	0	1	
	Δ																								
	▽																								
	Brighter	0	0	0	0	0	0	0	0	0	0	0	0	0	0	0	1	1	1	1	1	1	1	0	
	▽	0	0	0	0	0	0	0	0	0	0	0	0	0	0	0	1	1	1	1	1	1	1	0	
	Blue	0	0	0	0	0	0	0	0	0	0	0	0	0	0	0	1	1	1	1	1	1	1	1	
Gray Scale of White	Black	0	0	0	0	0	0	0	0	0	0	0	0	0	0	0	0	0	0	0	0	0	0	0	
	Δ	0	0	0	0	0	0	0	1	0	0	0	0	0	0	0	1	0	0	0	0	0	0	1	
	Darker	0	0	0	0	0	0	1	0	0	0	0	0	0	0	1	0	0	0	0	0	0	0	1	
	Δ																								
	▽																								
	Brighter	1	1	1	1	1	1	0	1	1	1	1	1	1	0	1	1	1	1	1	1	1	0	1	
	▽	1	1	1	1	1	1	0	1	1	1	1	1	1	0	1	1	1	1	1	1	1	1	0	
	White	1	1	1	1	1	1	1	1	1	1	1	1	1	1	1	1	1	1	1	1	1	1	1	

2.4 Signal Timing Specification

Timing Parameters

Parameter	Symbol	Value			Unit
		Min.	Typ.	Max.	
DCLK Frequency	fclk	138.5	148.5	153.2	MHz
Horizontal display area	thd	1920			pixel
HSYNC period time	th	2080	2200	2240	pixel
HSYNC blanking	thb+ thfp	160	280	320	pixel
Vertical display area	Tvd	1080			H
Frequency	fV	50	60	-	Hz
VSYNC period time	Tv	1110	1125	1140	H
VSYNC blanking	Tvb+ Tvfp	30	45	60	H

Note:

1. Best operation clock frequency is 148.5Mhz.
2. Frequency] = [H Total] * [V Total] * [vertical Frame rate] H Total, V Total and Frame rate] should operate within the range between Frequency_Min and Frequency_Max
3. Except Best operation clock frequency, FOS(Flicker & Brightness & Crosstalk, Etc.) are not guaranteed.
4. Main frequency Max is 60Hz

2.5 Power Sequence

To prevent a latch-up or DC operation of the Open Cell, the power on/off sequence shall be as shown in below.

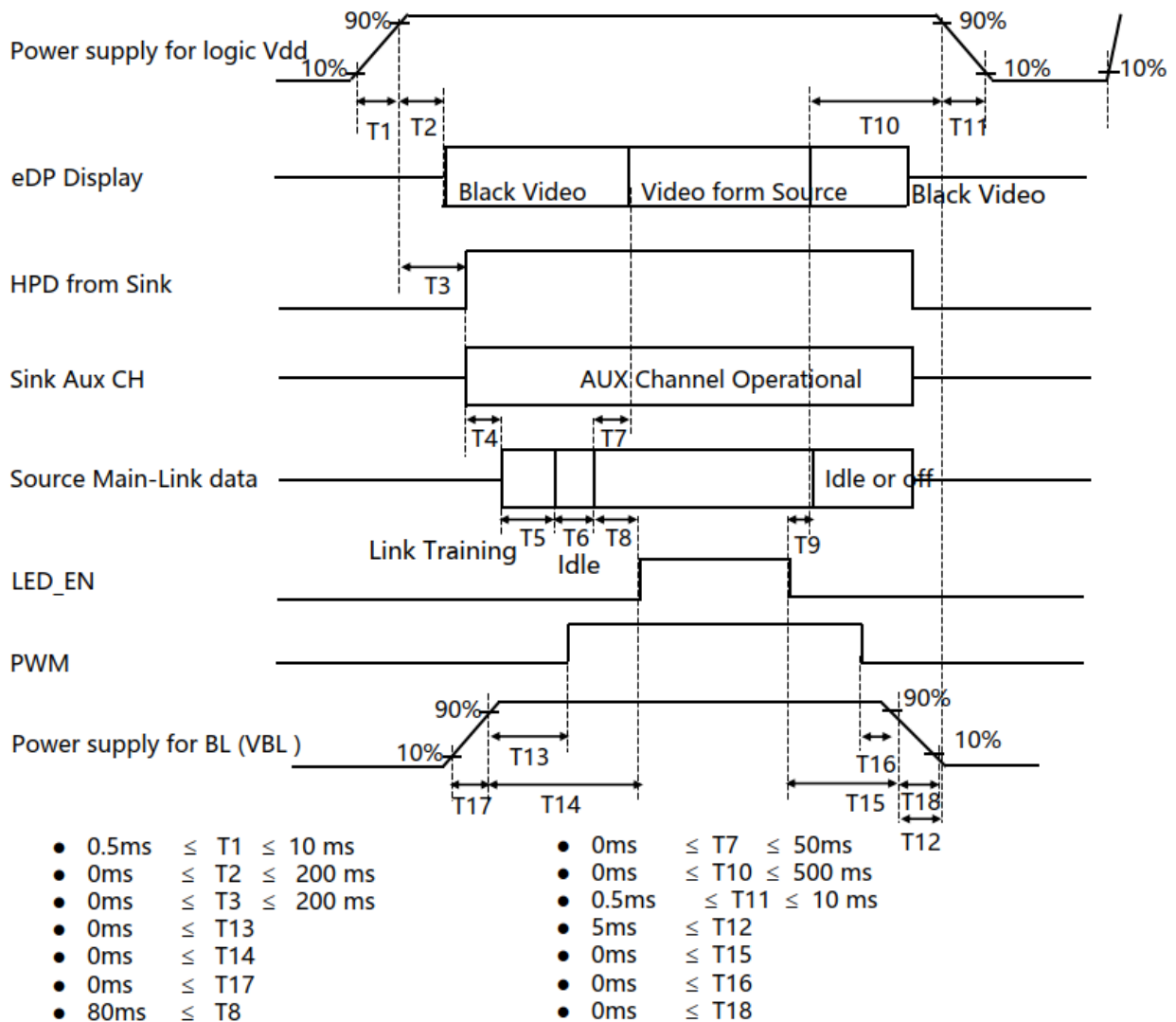

Notes:

1. When the power supply VDD is 0V, keep the level of input signals on the low or keep high impedance.
2. Do not keep the interface signal high impedance when power is on. Back Light must be turn on after power for logic and interface signal are valid.

3 Optical Specification

Item		Symbol	Condition	Min.	Typ.	Max.	Unit	Note
Color chromaticity	Red	Rx	$\theta_x=0$ $\theta_y=0$ CA-410	0.620	0.650	0.680	-	Test Mode: (2) (3)
		Ry		0.310	0.340	0.370	-	
	Green	Gx		0.288	0.318	0.348	-	
		Gy		0.590	0.620	0.650	-	
	Blue	Bx		0.121	0.151	0.181	-	
		By		0.018	0.048	0.078	-	
	White	Wx		0.236	0.266	0.296	-	
		Wy		0.241	0.271	0.301	-	
Center Luminance of White		Lc	$\theta_x=0$	450	500	650	cd/m ²	
Uniform		Lu	$\theta_y=0$ CA-410		85		%	
Contrast Ratio		CR	$\theta_x=0$	990:1	1100:1		-	Test Mode: (4)
Color Saturation		NTSC	$\theta_y=0$ Klein K-10		82		%	
Viewing Angle	Horizontal	θ_{x+}	$CR \geq 10$		85		Deg	Test Mode: (1)
		θ_{x-}			85			
	Vertical	θ_{y+}			85			
		θ_{y-}			85			

Test Mode :

(1) Definition of Viewing Angle (θ_x , θ_y):

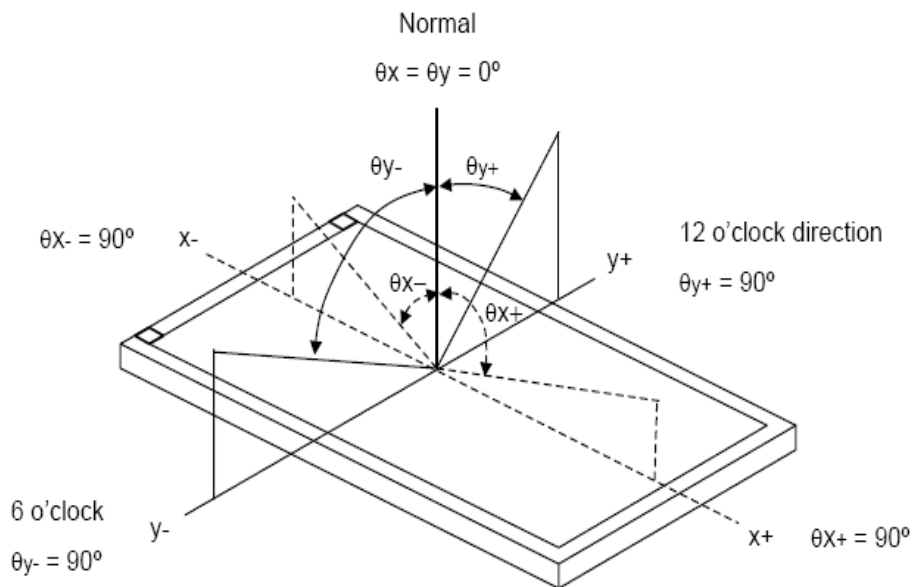

(2) Definition of Test Point:

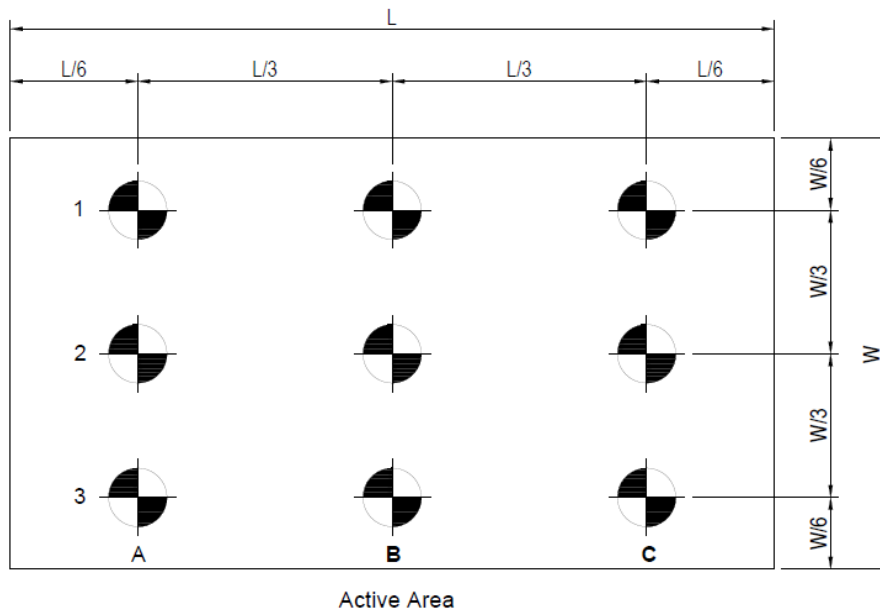

(3) CA-410 Measurement Setup:

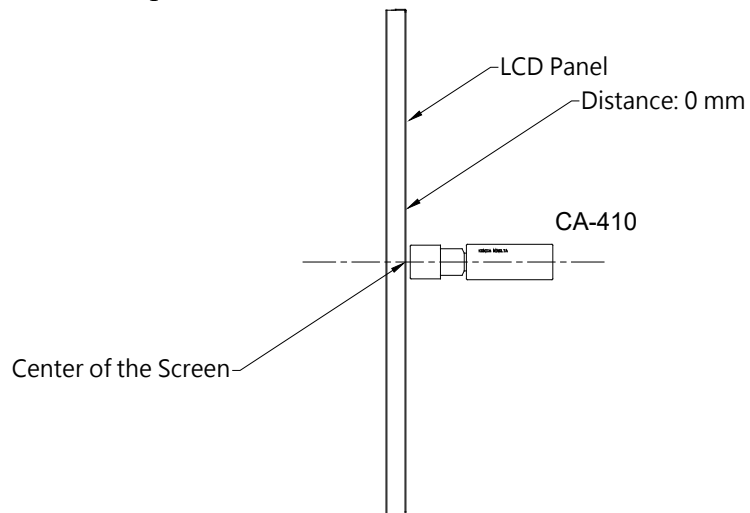

(4) Klein K-10 Measurement Setup:

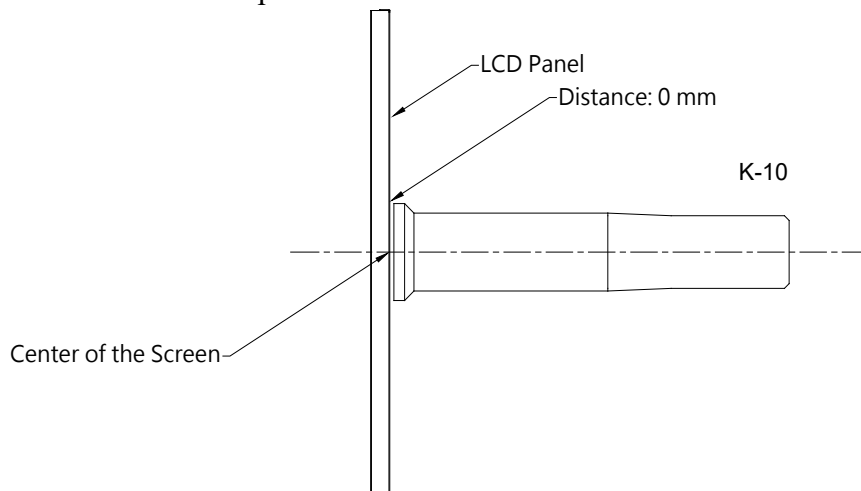

4 Electrical Characteristics

4.1 LED Driving Board Specifications

Item	Symbol	Condition	MIN.	TYP.	MAX.	Unit	Remark
Input Voltage	Vin		10.0	12.0	14.0	V	
Input Current (High Brightness)	IinH	Brightness = 100%	0.5	0.46	0.42	A	(1)
Input Power Consumption	Pin	Brightness = 100%	-----	5.52	-----	W	
LED Current (High Brightness)	IoutH	Brightness = 100%	-----	0.19	-----	A	
Working Frequency	W_Freq	Brightness = 100%	-----	400	-----	KHZ	
Brightness Control	DC mode						
	Vadj	Connection of Voltage	0.2	-----	4.8	V	(2)
	PWM mode						
	PWM	Connect to PWM	0	-----	100	%	(3)
Freq	-----		200	-----	Hz	(4)	
ON/OFF Control	Von	Normal Operation	2	-----	5	V	
	Voff		0	-----	0.8	V	
Output Voltage	Vout	Brightness = 100%	-----	27	-----	V	
Efficiency	η	Brightness = 100%	-----	93	-----	%	(5)

Remark:

- (1) This data is based on the testing result of practical input voltage, Iin is measured by related Vin (min, typ, max). If the voltage is increased, the current will decrease. If the voltage is decrease, the current will increase
- (2) Max brightness at Vadj=0.2V. Min brightness at Vadj=4.8V.
- (3) Max dimming ratio = 1:100.
- (4) Frequency can be adjusted in accordance with demand(120Hz minimum, or lights will be flickering)
- (5) $\eta_{max} = V_{out(max)} * I_{outH(max)} / V_{in(max)} * I_{inH(min)}$
 $\eta_{min} = V_{out(min)} * I_{outH(min)} / V_{in(min)} * I_{inH(max)}$

4.2 LED Driving Board Connector Pin Assignment

Input Connector: J3(JST S9B-PH-SM3-TB or Compatible)

PIN No	Symbol	Description
1	Vin	DC+
2	Vin	DC+
3	Vin	DC+
4	GND	Ground
5	GND	Ground
6	GND	Ground
7	Brightness	Brightness Control
8	Control	ON/OFF Control
9	CL	PWM or DC selection (Low → DC , Hi → PWM)

Output Connector: J1(JST S2B-EH or Compatible)

PIN NO	Symbol	Description
1	Output	LED High Voltage(+)
2	Output	LED Low Voltage (-)

DC or PWM Connector :J4

PIN NO	Symbol	Description
1	DC	JUMP pin 1,2 LED driver is DC input
2	GND	JUMP pin 2,3
3	PWM	LED driver is PWM input

4.3 LED Driving Board Mechanical Characteristics

Dimension: 52 mm x 26 mm x 10.5mm

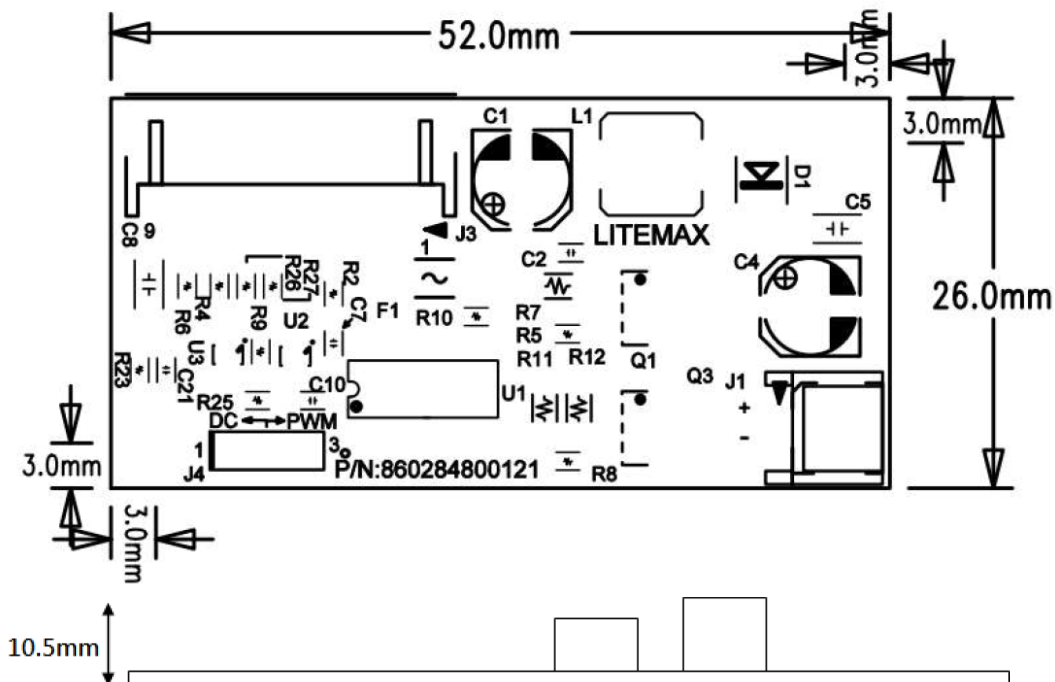

5 Mechanical Drawing

Unit:mm

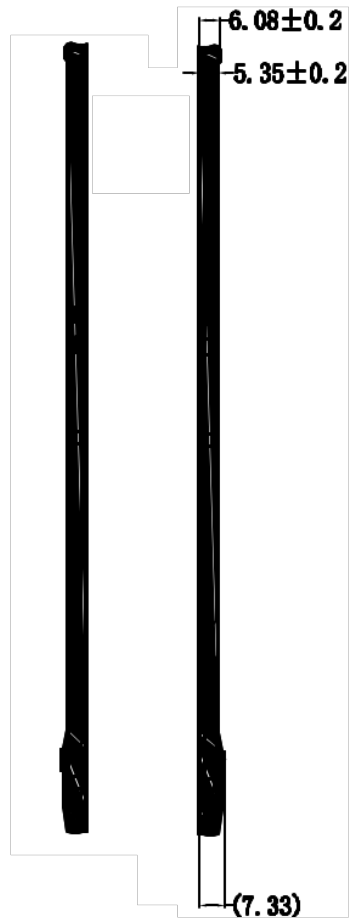
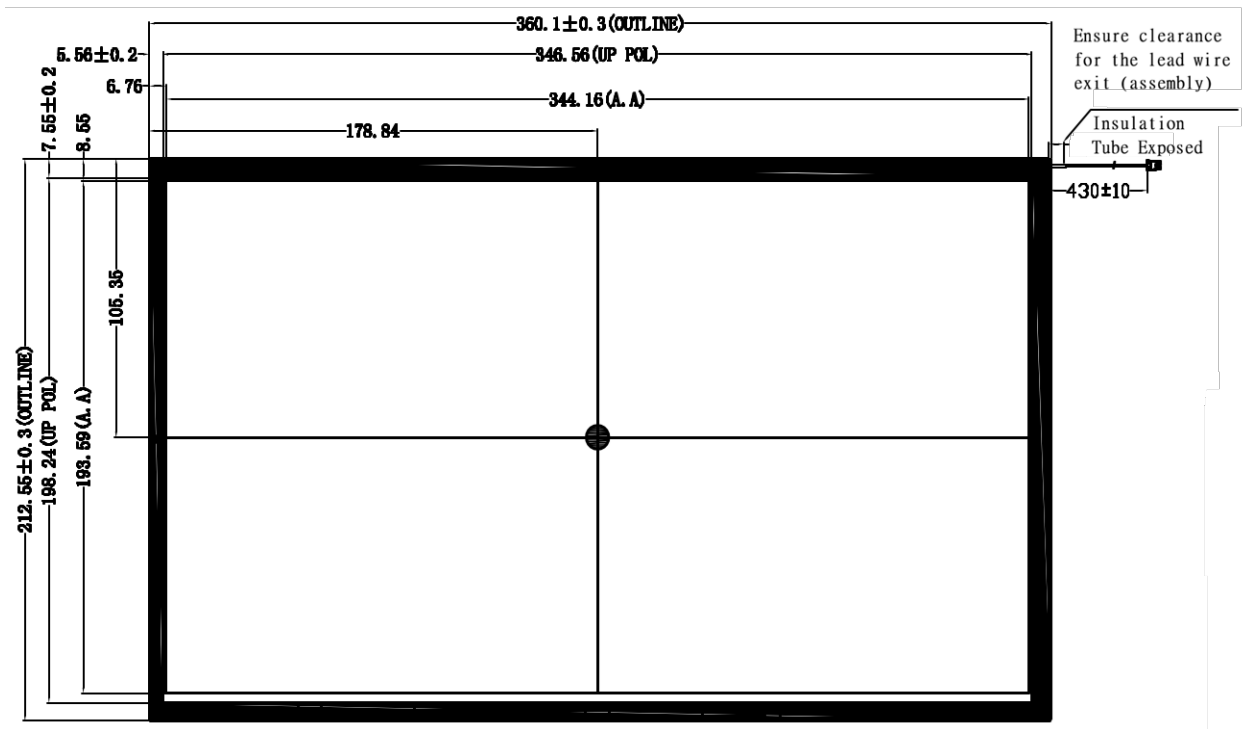

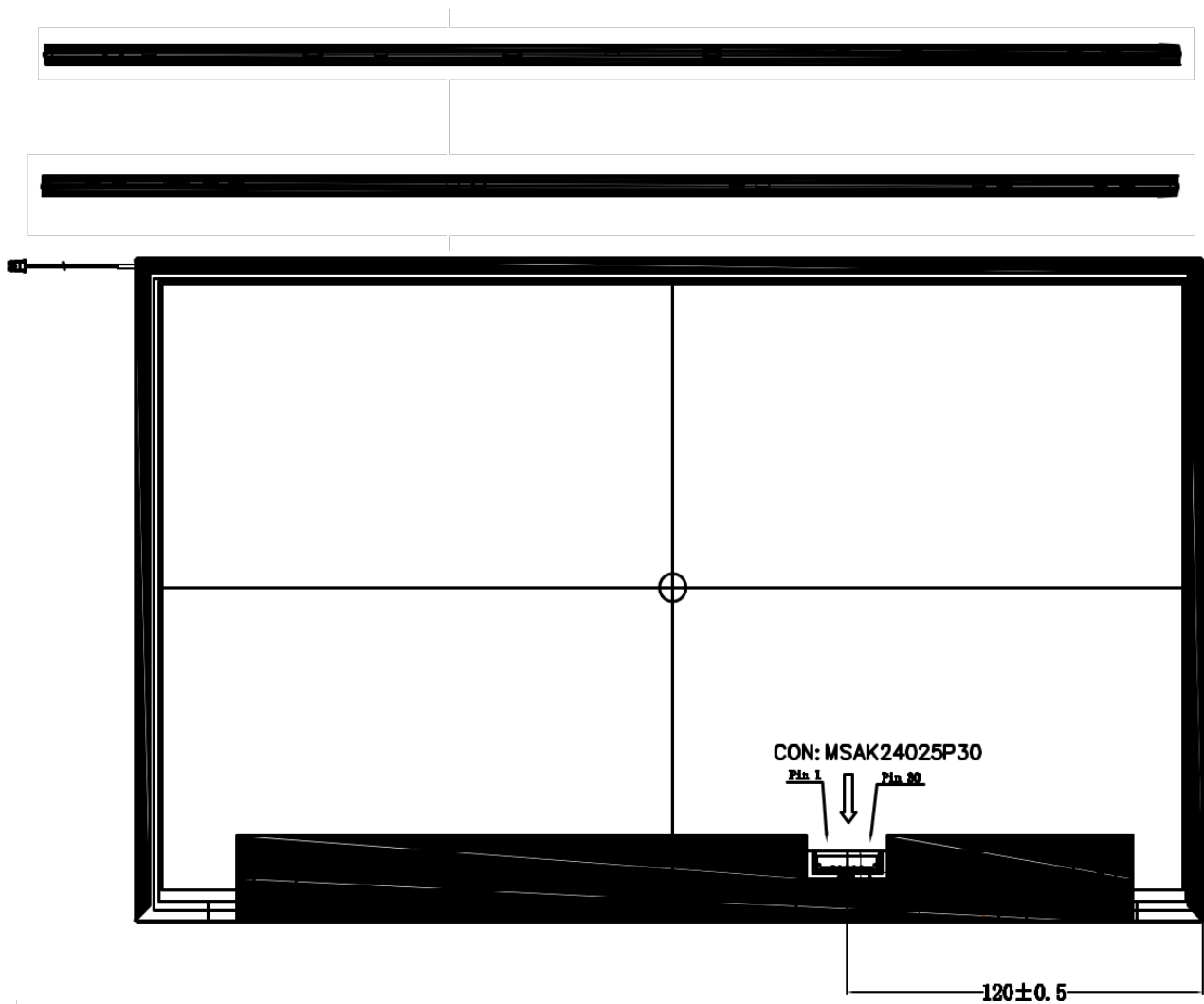

Red Wire: Positive (+)



Black Wire: Negative (-)

Notes:

1. Unit:mm.
2. Do not scale drawing.
3. All radii without dimension R0.2.
4.  Modification Mark.
5. draft angle: 1°
6. UnSpecified Tolerance is ± 0.2
7. All materials comply with RoHS

6 AD68862HP Board & OSD Functions

We developed this A/D board to support industrial high brightness and commercial applications. This A/D board has many functions. It has a HDMI and Display Port input. Rev.1 is European RoHS compliant.

General Description

- Max resolution 1920 x 1080 60Hz
- One DP 1.2, supports 1920 x 1080 60Hz
- One HDMI 1.4, supports 1920 x 1080 60Hz
- Embedded MCU with ADC port for VR, Light Sensor application. (Optional)
- Embedded OSD.
- Support panel voltage 3.3/ 5/ 12 V
- Support eDP panel.
- Support Dual/Single LVDS
- Support 2.8W speaker x 2 (Optional)
- Size 100mm*72mm
- Support output voltage 12V(1A) or 5V(1A)

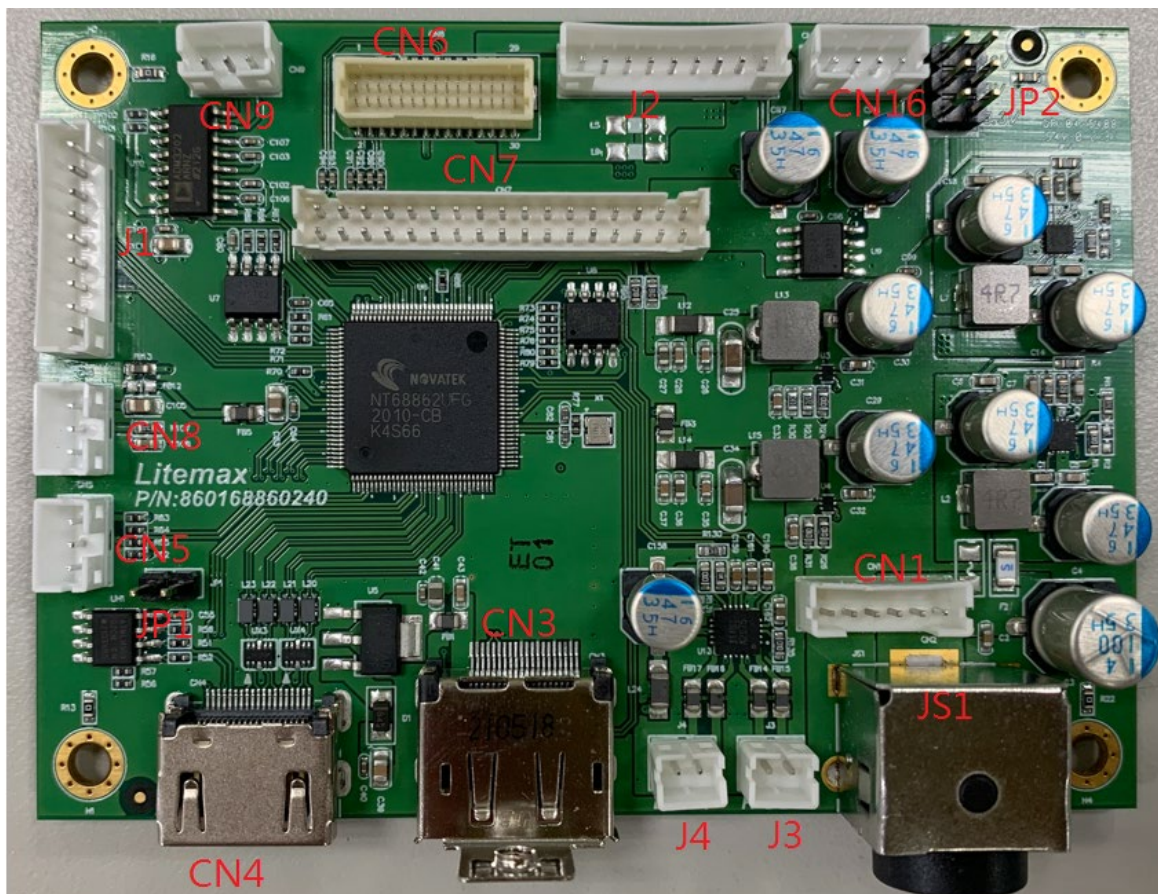

Outline Dimensions

AD68862HP 100 mm x 72mm

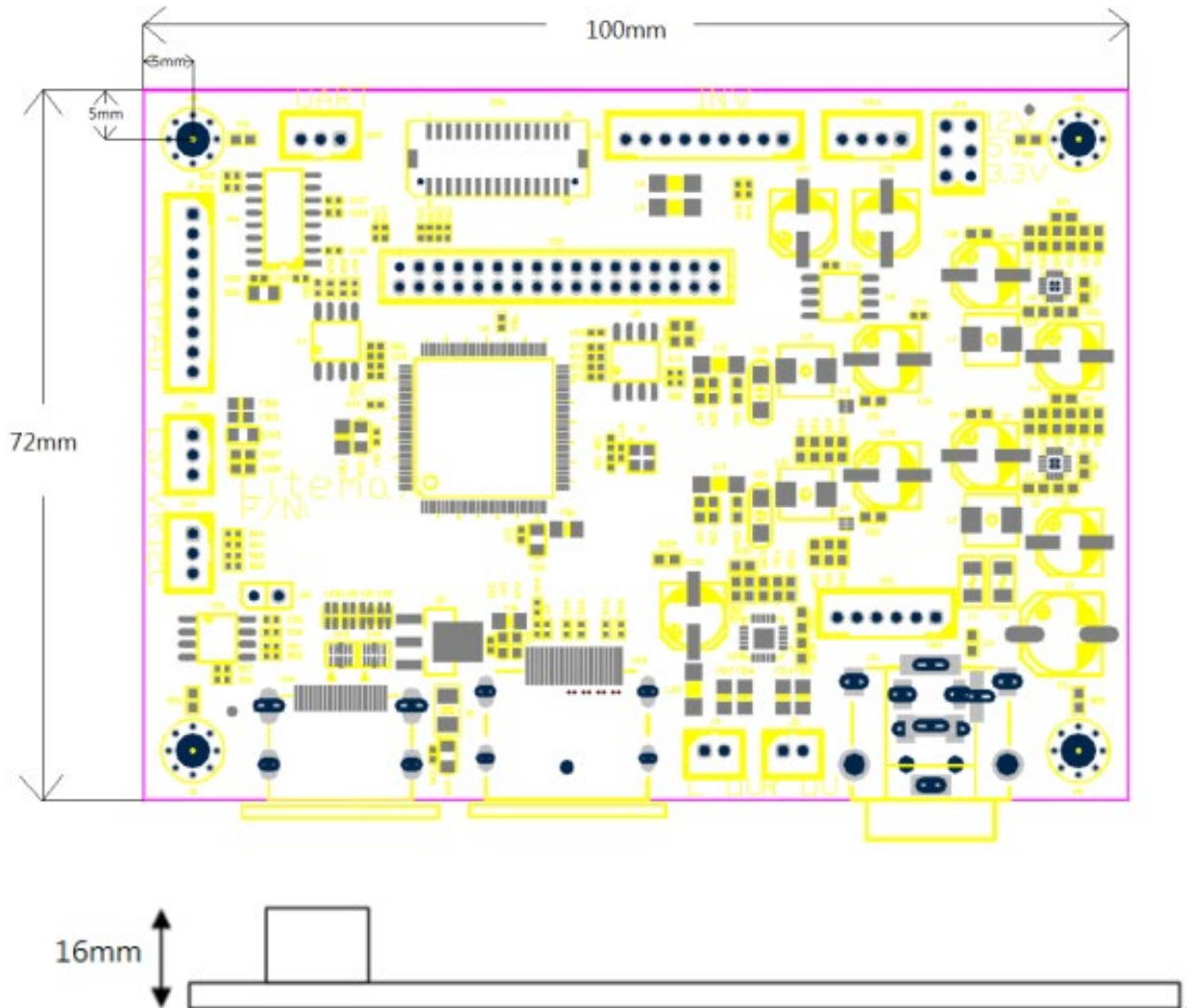

AD68862HP Board Pin Define

CN6: eDP output(Wafer 1.0mm, 15*2P)

Pin	Function	Pin	Function
1	TX0P	16	TXAUX-
2	TX0N	17	TX_HPDP
3	TX1P	18	GND
4	TX1N	19	VCC
5	GND	20	VCC
6	GND	21	DIM_EDP
7	NC	22	ON/OFF_EDP
8	NC	23	INVGND
9	GND	24	INVGND
10	GND	25	INVGND
11	NC	26	GND
12	NC	27	12INV
13	GND	28	12INV
14	GND	29	12INV
15	TXAUX+	30	12INV

CN7: LVDS output(Wafer 2.0mm,17x2P)

Pin	Function	Pin	Function
1	RXO0-	18	RXE1+
2	RXO0+	19	RXE2-
3	RXO1-	20	RXE2+
4	RXO1+	21	RXEC-
5	RXO2-	22	RXEC+
6	RXO2+	23	RXE3-
7	RXOC-	24	RXE3+
8	RXOC+	25	NC
9	RXO3-	26	NC
10	RXO3+	27	GND
11	NC	28	GND
12	NC	29	+3.3V
13	GND	30	GND
14	GND	31	VCC
15	RXE0-	32	VCC
16	RXE0+	33	VCC
17	RXE1-	34	VCC

CN3: DP input

Pin	Function	Pin	Function
1	ML_Lane3(n)	11	GND
2	GND	12	ML_Lane0(p)
3	ML_Lane3(p)	13	CONFIG1
4	ML_Lane2(n)	14	CONFIG2
5	GND	15	AUX_CH(p)
6	ML_Lane2(p)	16	GND
7	ML_Lane1(n)	17	AUX_CH(n)
8	GND	18	Hot_Plug
9	ML_Lane1(p)	19	Return
10	ML_Lane0(n)	20	DP_PWR

CN4: HDMI input

Pin	Function	Pin	Function	Pin	Function
1	RX2+	9	RX0-	17	GND
2	GND	10	TMDS Clock+	18	HDMI +5V
3	RX2-	11	HDMI DET	19	HPD
4	RX1+	12	TMDS Clock-		
5	GND	13	NC		
6	RX1-	14	NC		
7	RX0+	15	HDMI_SCL		
8	GND	16	HDMI_SDA		

CN1: Power input (Wafer 2.0mm pitch 6 pin)

Pin	Function	Pin	Function
1	Power Input	4	GND
2	Power Input	5	GND
3	Power Input	6	GND

JS1: Power input (Power Din 4 pin)

Pin	Function	Pin	Function
1	Power Input	3	GND
2	Power Input	4	GND

CN2: Power input (Power Jack 3 pin)

Pin	Function	Pin	Function
1	Power Input	3	GND
2	GND		

CN16: Power output (Wafer 2.0mm pitch 4 pin)

Pin	Function	Pin	Function
1	+5V(1A)	3	+12V(1A)
2	GND	4	GND

J2: Backlight Power and Control (Wafer 2.0mm pitch 9 pin)

Pin	Function	Pin	Function
1	DC/PWM SEL	6	GND
2	Enable	7	12V (Note3)
3	Dimming	8	12V (Note3)
4	GND	9	12V (Note3)
5	GND		

Note3: Pin 7,8,9 are for 12V version only. If you choose 24V version, these 3 pin are NC.

J1: Keypad (Wafer 2.0mm pitch 9 pin)

Pin	Function	Pin	Function
1	POWER KEY	6	MENU KEY
2	GREEN LED	7	NC
3	RED LED	8	GND
4	DOWN KEY	9	NC
5	UP KEY		

CN8: Light sensor (Wafer 2.0mm pitch 3 pin)

Pin	Function	Pin	Function
1	3.3V	3	GND
2	Sensor Out		

JP2: Panel power selection (2.54mm pitch 2x3 jump)

Pin	Function	Pin	Function
1-2 close	3.3V	5-6 close	12V
3-4 close	5V		

CN9: UART (Wafer 2.0mm pitch 3 pin)

Pin	Function	Pin	Function
1	TX	3	GND
2	RX		

CN5: I2C (Wafer 2.0mm pitch 3 pin)

Pin	Function	Pin	Function
1	SDA	3	GND
2	SCL		

J3: Audio out R (Wafer 2.0mm pitch 2 pin)(2.8W 4ΩLoad)

Pin	Function	Pin	Function
1	ROUTP	2	ROUTN

J4: Audio out L (Wafer 2.0mm pitch 2 pin) (2.8W 4ΩLoad)

Pin	Function	Pin	Function
1	LOUTP	2	LOUTN

6.1 OSD Function

MEMBRANE CONTROL BUTTOM

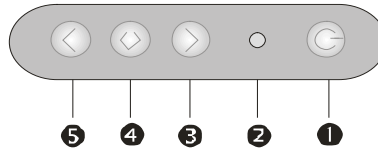

- ❶ **POWER SWITCH:** Pushing the power switch will turn the monitor on. Pushing it again to turn the monitor off.
- ❷ **Power LED:** Power ON-Green / Power off-No.
- ❸ **Up Key >:** Increase item number or value of the selected item.
- ❹ **Menu Key:** Enter to the OSD adjustment menu. It also used for go back to previous menu for sub-menu, and the change data don't save to memory.
- ❺ **Down Key <:** Decrease item number or item value when OSD is on.

Screen Adjustment Operation Procedure

1. Entering the screen adjustment

The setting switches are normally at stand-by. Push the **Menu Key** once to display the main menu of the screen adjustment. The adjustable items will be displayed in the main menu.

2. Entering the settings

Use the **Down Key <** and **Up Key >** buttons to select the desired setting icon and push the **SELECT** button to enter sub-menu.

3. Change the settings

After the sub-menu appears, use the **Down Key <** and **Up Key >** buttons to change the setting values.

4. Save

After finishing the adjustment, push the **SELECT** button to memorize the setting.

5. Return & Exit the main menu

Exit the screen adjustment; push the "MENU" button. When no operation is done around 10 sec (default OSD timeout), it goes back to the stand-by mode and no more switching is accepted except MENU to restart the setting.

6.2 OSD Menu

Here are some instructions for you to use the OSD (On Screen Display). By pressing the “menu”, you will see the below picture.

Timing shows resolution and V-frequency of the panel. This 2 information is not changeable by user.



There are 6 sub menus within the OSD user interface:

Brightness, Signal Select, Sound, Color, Tools, and Exit.



Brightness

When you press the “menu” button, you enter the “Brightness” sub directory. In this directory, you will see 6 selections: **Brightness Mode, OSD Brightness, Contrast, Sharpness, Auto Tune, Exit.**



Brightness Mode :

press “menu” once, you can go into the Brightness Mode.



VR: (OPTION)

press this Icon to activate the VR control of brightness.



Ambient light sensor: (OPTION)

press this Icon, must to accompany with Litemax ambient light sensor to auto dimming.





OSD Brightness :

Press the “menu” once, to adjust the brightness. Press “left” to dim down the brightness to “0”, press “right” to increase the brightness to “100”

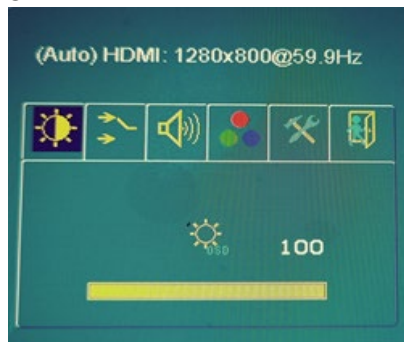

Contrast :

Press “Menu” once, you can adjust the contrast from “0” to “100” by pressing the “Left” and “Right”.

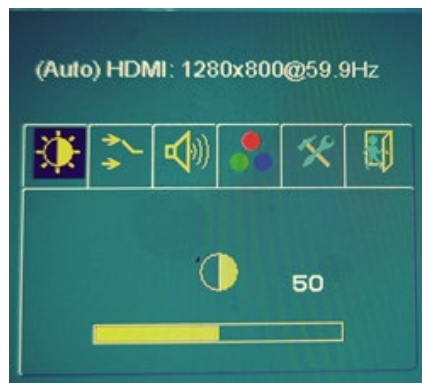

Sharpness :

Press “Menu” once, you can adjust the Sharpness from “0” to “4” by pressing the “Left” and “Right”.

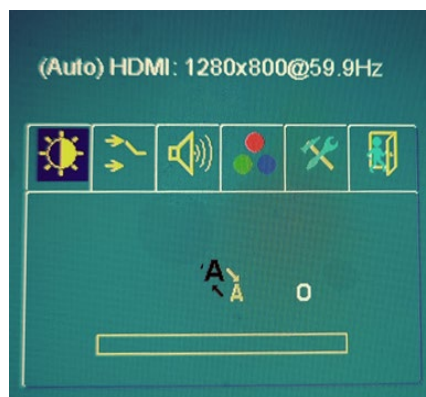



Auto Tune : (VGA only)

Press “Menu” once, you can activate the Auto Tune.

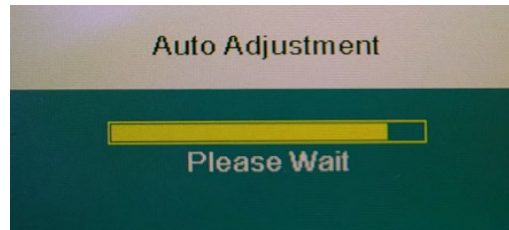

Exit: back to the beginning menu.



Input Signal: (default auto detect)

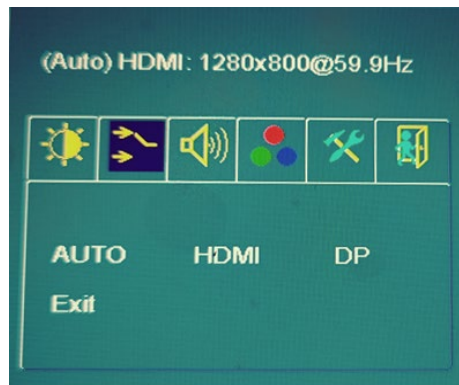

AUTO **AUTO:** auto detect

HDMI **HDMI:** HDMI input

DP **DP:** DisplayPort input

Exit **Exit:** back to the beginning menu.



Audio:

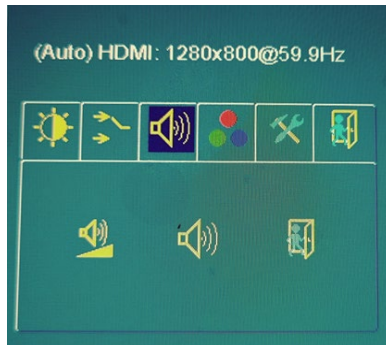

Audio Volume: Audio volume adjustment, from “0” to “100”.



UnMute/Mute: You can mute the speaker by pressing this option.



Exit: back to the beginning menu.



Color:

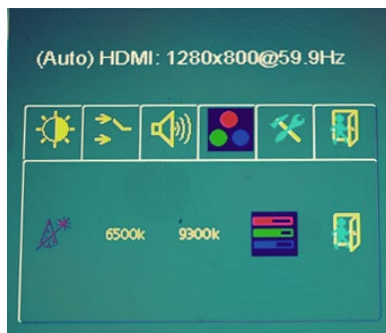

Auto Color (VGA only) :

By navigating over to the “Auto Color” option, optimal color performance is invoked.



Color Tempure_6500K: Warm color scheme.



Color Tempure_9300K: Cold color scheme.



Color Temperature User Define: Default is 100 for “R”, “G”, and “B”. Range is “0” to “255”.



Exit: back to the beginning menu.



Other Setting:



HPos: You can shift the screen horizontally using this function.



VPos: You can shift the screen vertically using this function.



Rotation: You can rotate the screen to 0° (No) · 270° (Yes).



Load Default: You can load the default data using this function.



Exit: back to the beginning menu.

< **Hot Key** >

Left click to display brightness adjustment.



Right click to display Input Source Menu.

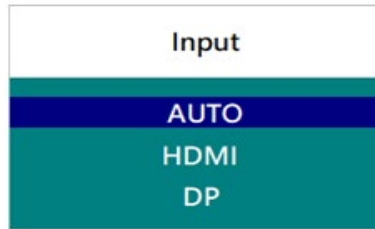

<Others>

Signal Information will be displayed after powering on or switching the signal.

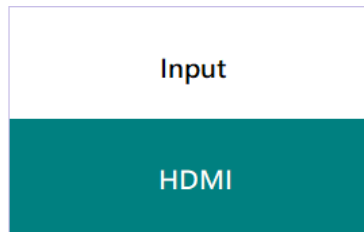

(Signal Information)

NO VIDEO INPUT will be displayed when there is no signal input.

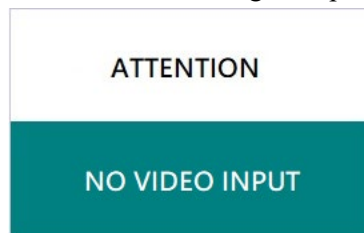

(No Video Input)

CHECK CABLE CONNECTION will be displayed when the signal cable is not connected.

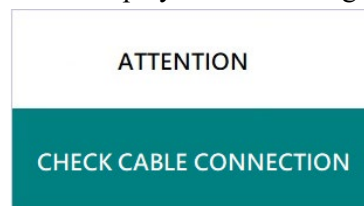

(Check Cable Connection)

7 Precautions

7.1 Handling and Mounting Precautions

- (1) The module should be assembled into the system firmly by using every mounting hole. Do not apply rough force such as bending or twisting to the LCD during assembly.
- (2) You should consider the mounting structure so that uneven force (ex. Twisted stress, Concentrated stress) is not applied to the module. And the case on which a module is mounted should have sufficient strength so that external force is not transmitted directly to the LCD module.
- (3) While assembling or installing LCD modules, it can only be in the clean area. The dust and oil may cause electrical short or damage the polarizer.
- (4) Use fingerstalls or soft gloves in order to keep display clean during the incoming inspection and assembly process.
- (5) Do not press or scratch the surface harder than a HB pencil lead on the panel because the polarizer is very soft and easily be scratched.
- (6) Please attach the surface transparent protection film to the surface in order to protect the polarizer. Transparent protection film should have sufficient strength in order to the resist external force.
- (7) When the transparent protection film is peeled off, static electricity is generated between the film and polarizer. This should be peeled off slowly and carefully by people who are electrically grounded and with well ion-blown equipment or in such a condition, etc.
- (8) If the surface of the polarizer is dirty, please clean it by some absorbent cotton or soft cloth. Do not use Ketone type materials (ex. Acetone), Ethyl alcohol, Toluene, Ethyl acid or Methyl chloride. It might permanently damage the polarizer due to chemical reaction.
- (9) Wipe off water droplets or oil immediately. Staining and discoloration may occur if they left on panel for a long time.
- (10) If the liquid crystal material leaks from the panel, it should be kept away from the eyes or mouth. In case of contacting with hands, legs or clothes, it must be washed away thoroughly with soap.
- (11) Protect the LCD module from static electricity, it may cause damage to the C-MOS Gate Array IC.
- (12) Do not disassemble the module.
- (13) Do not pull or fold the lamp wire.
- (14) Pins of I/F connector should not be touched directly with bare hands.

7.2 Storage Precautions

- (1) High temperature or humidity may reduce the performance of LCD module. Please store LCD module within the specified storage conditions.
- (2) If possible store them in a dark place. Do not expose the module to sunlight or fluorescent light. Keep the temperature between 5°C and 35°C at normal humidity.
- (3) It is dangerous that moisture come into or contacted the LCD module, because the moisture may damage LCD module when it is operating.
- (4) The polarizer surface should not come in contact with any other object. It is recommended that they be stored in the container in which they were shipped.

7.3 Operation Precautions

- (1) Do not pull the I/F connector in or out while the LCD module is operating.
- (2) Always follow the correct power on/off sequence when LCD module is connecting and operating. This can prevent the CMOS LSI chips from damage during latch-up.
- (3) Response time depends on the temperature. (In lower temperature, it becomes longer.)
- (4) Brightness depends on the temperature. (In lower temperature, it becomes lower.)
- (5) Be careful for condensation at sudden temperature change. Condensation makes damage to polarizer or electrical contacted parts. And after fading condensation, smear or spot will occur.
- (6) Module has high frequency circuits. Sufficient suppression to the electromagnetic interference shall be done by system manufacturers. Grounding and shielding methods are very important to minimize the interference.
- (7) Please do not give any mechanical and/or acoustical impact to module. Otherwise, module can't be operated its full characteristics perfectly.
- (8) Since a module is composed of electronic circuits, it is not strong to electrostatic discharge. Make certain that treatment persons are connected to ground through wrist band etc. And don't touch interface pin directly.
- (9) Do not display the fixed pattern for a long time because it may cause image sticking.
- (10) In order to prevent image sticking, periodical power-off or screen save is needed after fixed pattern long time display.
- (11) Black image or moving image is strongly recommended as a screen save.
- (12) Static information display recommended to use with moving image. Cycling display between 10 minutes' information (static) display and 10 seconds' moving image.
- (13) Background and character (image) color change is recommended. Use different colors for background and character, respectively. And change colors themselves periodically.
- (14) LCD system is required to place in well-ventilated environment. Adapting active cooling system is highly recommended.
- (15) Product reliability and functions are only guaranteed when the product is used under right operation usages.
- (16) If product will be used in extreme conditions, such as high temperature/ humidity, shock and vibration it is strongly recommended to contact Litemax for filed application engineering advice. Otherwise, its reliability and function may not be guaranteed. Extreme conditions are commonly found at airports, transit stations, taxi-top, in vehicle and controlling systems.

8 Disclaimer

All information in this document are subject to change, please constant LiteMax for any new design.