



LITEMAX

DLD5500-I

Sunlight Readable 55" LED B/L LCD

User Manual

Approved by	Checked by	Prepared by

LITEMAX Electronics Inc.
8F, No.137, Lane 235, Bau-chiau Rd.,
Shin-dian Dist., New Taipei City, Taiwan
R.O.C.
Tel : 886-2-8919-1858
Fax: 886-2-8919-1300
Homepage: <http://www.litemax.com>

Record of Revision

Version and Date	Page	Old Description	New Description	Remark
Oct/30/2025	all		Initial release	

Contents

Record of Revision	2
Contents	3
1 General Description.....	4
1.1 Features	4
1.2 General Specifications.....	4
1.3 Absolute Maximum Ratings.....	5
2 Electrical Absolute Ratings.....	6
2.1 TFT LCD Module	6
2.2 Electrical Characteristics.....	7
2.3 Input Terminal Pin Assignment.....	9
2.4 Color Data Input Assignment	12
2.5 Flicker (Vcom) Adjustment.....	13
2.6 Input Signal Timing Specifications	14
2.7 Timing Diagram	16
2.8 Power On/Off Sequence.....	19
3 Optical Specification	20
4 LED Driving Board Specifications.....	22
4.1 Operating Characteristics	22
4.2 Connector Socket	23
4.3 Mechanical Characteristics	24
5 Mechanical Drawing	25
6 AD9131DHP Board & OSD Functions	27
6.1 General Description	27
6.2 Outline Dimensions.....	28
6.3 AD9131DHP Board Pin Define	29
6.4 OSD Function.....	35
6.5 OSD Menu	36
7 Precautions.....	37
7.1 Handling and Mounting Precautions.....	37
7.2 Storage Precautions	37
7.3 Operation Precautions	38
8 Disclaimer.....	38

1 General Description

The **DLD5500-I** is a 55 inch industrial grade sunlight readable LCD, with high brightness 2500 nits, it produce sharp images, crisp text and lifelike colors. The Durapixel LED backlight technology ensures high reliability and low power consumption, suitable for outdoor application, kiosk, factory automation, military, transportation and gaming application.

1.1 Features

- High Brightness 2500 nits
- Sunlight Readable
- Wide Operation Temperature (-30 °C ~ 70 °C)
- LCD Blackening Defect Free (H-Tni 110 °C)
- Surface Treatment (Haze 25%)
- Low Power Consumption
- BL MTBF: 100,000 hours

1.2 General Specifications

Model Name	DLD5500-I
Description	55" TFT LCD, 2500 nits LED Backlight, 3840x2160
Screen Size	55"
Display Area (mm)	1209.6(H) x 680.4(V)
Brightness	2500 cd/m ²
Resolution	3840x2160
Aspect Ratio	16 : 9
Contrast Ratio	6000 : 1
Pixel Pitch (mm)	0.315(H) x 0.315(V)
Pixel Per Inch (PPI)	80
Viewing Angle	178°(H),178°(V)
Color Saturation (NTSC)	83%
Display Colors	1.07G
Response Time (Typical)	9.5ms
Panel Interface	V-by-One
Input Interface	DVI-I, HDMI, DP
Input Power	AC100~240V
Power Consumption	280W
OSD Key	5 Keys (Power Switch, Menu, +, -, Exit)
OSD Control	Brightness, Color, Contrast, Auto Turing, H/V Position...etc
Dimensions (mm)	1240.1 x 711.1 x 107.5 mm
Bezel Size(U/B/L/R)	15.35/15.35/15.25/15.25 mm
Mounting	400x200, 400x300
Weight (Net)	27 kg
Operating Temperature	-30 °C ~ 70 °C
Storage Temperature	-30 °C ~ 70 °C

DLD= Panel + LED Driving Board + AD Control Board + Chassis

1.3 Absolute Maximum Ratings

Permanent damage may occur if exceeding the following maximum rating.

Item	Symbol	Value		Unit	Note
		Min.	Max.		
Storage Temperature	T _{ST}	-30	+70	°C	(1), (3), (4)
Operating Ambient Temperature	T _{OP}	-30	+70	°C	(1), (2), (3), (4)
Panel Surface Temperature	P _{ST}		+80	°C	(2)

Note (1) Temperature and relative humidity range is shown in the figure below:

- (a) 90 %RH Max. (Ta <=40°C)
- (b) Wet-bulb temperature should be 39 °C Max.
- (c) No condensation.

Note (2) (a) Thermal management should be considered in final product design to prevent the surface temperature of display area from being over 80 °C. The range of operating temperature may degrade in case of improper thermal management in final product design.

- (b) Surface temperature is measured at 70°C Dry condition.

Note (3) The rating of environment is based on LCD module. Leave LCD cell alone, this environment condition can't be guaranteed. Except LCD cell, the customer has to consider the ability of other parts of LCD module and LCD module process.

Note (4) Low temperature start can only be performed when the ambient temperature is greater than -20°C.

Response time depends on the temperature. (In lower temperature, it becomes longer.)

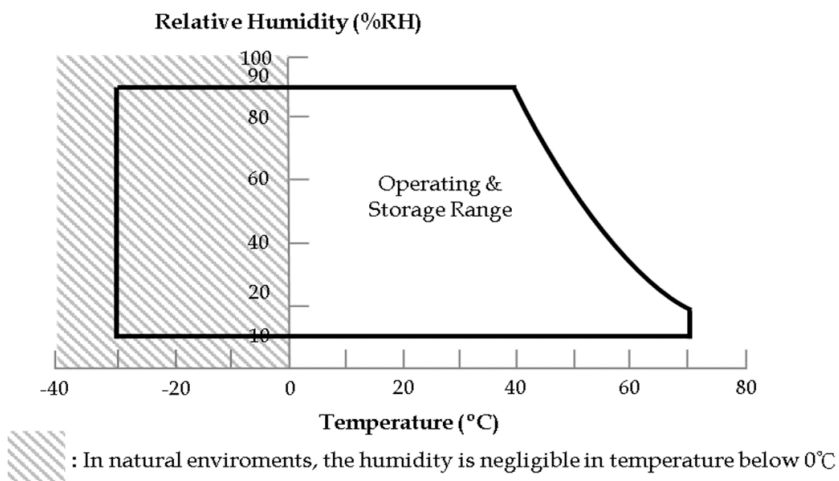

2 Electrical Absolute Ratings

2.1 TFT LCD Module

Item	Symbol	Value		Unit	Note
		Min.	Max.		
Power Supply Voltage	VCC	-0.3	13.5	V	(1)
Logic Input Voltage	VIN	-0.3	3.6	V	
Source Driver Temperature	-	-	125	°C	(2)
Component Temperature	-	-	100	°C	

Note

- (1) Permanent damage to the device may occur if maximum values are exceeded. Function operation should be restricted to the conditions described under Normal Operating Conditions.
- (2) The surface temperature of Source Driver should be controlled under 125°C, operating over thermal spec will cause the damage or decrease of lifetime.

2.2 Electrical Characteristics

(Ta = 25 ± 2 °C)

Parameter	Symbol	Value			Unit	Note	
		Min.	Typ.	Max.			
Power Supply Voltage	V _{CC}	10.8	12	13.2	V	(1)	
Rush Current	I _{RUSH}	—	—	(4.03)	A	(2)	
Power consumption	White Pattern	PT	—	(19.706)	(21.677)	W	(3)
	Black Pattern	PT	—	(8.911)	(9.802)		
	Heavy Loading pattern EX : Horizontal Stripe	PT	—	(18.975)	(20.873)		
Power Supply Current	White Pattern	—	—	(1.714)	(2.045)	A	
	Black Pattern	—	—	(0.767)	(0.909)		
	Heavy Loading pattern EX : Horizontal Stripe	—	—	(1.643)	(1.975)		
VbyOne HS	Differential Input High Threshold Voltage	VLVTH	—	—	+50	mV	
	Differential Input Low Threshold Voltage	VLVTL	-50	—	—	mV	
	Differential Input Resistor	RRIN	80	100	120	ohm	
CMOS interface	Input High Threshold Voltage	V _{IH}	2.7	—	3.6	V	
	Input Low Threshold Voltage	V _{IL}	0	—	0.7	V	

Note (1)The module should be always operated within above ranges. The ripple voltage should be controlled under 10% of V_{CC} (Typ.)

Note (2)Measurement Conditions:

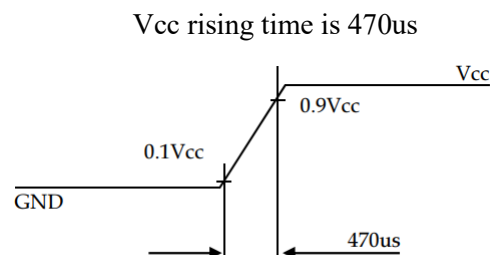
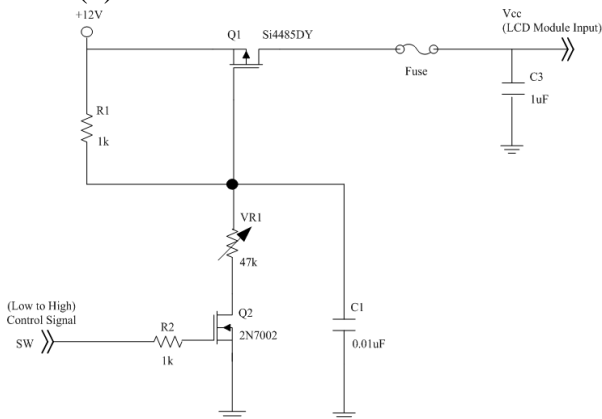

Note (3) The specified power consumption and power supply current is under the conditions at $V_{cc} = 12\text{ V}$, $T_a = 25 \pm 2\text{ }^\circ\text{C}$, $f_r = 50/60\text{Hz}$, whereas a power dissipation check pattern below is displayed.

a. White Pattern



Active Area

b. Black Pattern



Active Area

c. Heavy Loading pattern

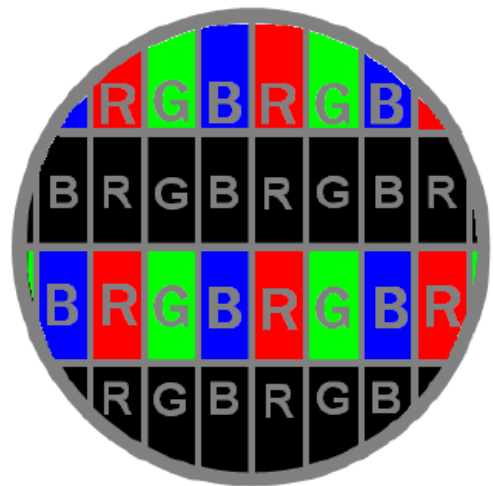
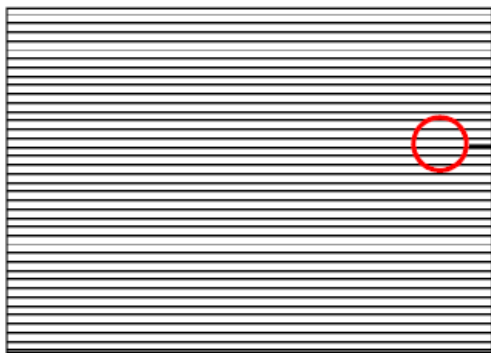

2.3 Input Terminal Pin Assignment

CNC04 Connector Pin Assignment: [FF01-42T-5131(FCN), 0-51162217-5(XDYT), FFSKL05011N51C(STM)]

Pin	Name	Description	Note
1	Vin	Power input (+12V)	(5)
2	Vin	Power input (+12V)	
3	Vin	Power input (+12V)	
4	Vin	Power input (+12V)	
5	Vin	Power input (+12V)	
6	Vin	Power input (+12V)	
7	Vin	Power input (+12V)	
8	Vin	Power input (+12V)	
9	N.C.	No Connection	
10	GND	Ground	
11	GND	Ground	
12	GND	Ground	
13	GND	Ground	
14	GND	Ground	
15	N.C.	No Connection	(4)
16	N.C.	No Connection	
17	N.C.	No Connection	
18	SDA	I2C Data signal ,(open drain)	(8)
19	SCL	I2C Clock signal,(open drain)	
20	N.C.	No Connection	(4)
21	N.C.	No Connection	
22	N.C.	No Connection	(4)
23	N.C.	No Connection	(4)
24	N.C.	No Connection	
25	HTPDN	No Connection or ground	(9)
26	LOCKN	Lock detect output, Open drain.	
27	GND	Ground	
28	RX0N	1 ST Pixel Negative VbyOne differential data input in area A. Lan 0	(1)
29	RX0P	1 ST Pixel Positive VbyOne differential data input in area A. Lan 0	
30	GND	Ground	
31	RX1N	2 ND Pixel Negative VbyOne differential data input in area A. Lan 1	(1)
32	RX1P	2 ND Pixel Positive VbyOne differential data input in area A. Lan 1	
33	GND	Ground	
34	RX2N	3 RD Pixel Negative VbyOne differential data input in area A. Lan 2	(1)
35	RX2P	3 RD Pixel Positive VbyOne differential data input in area A. Lan 2	
36	GND	Ground	
37	RX3N	4 TH Pixel Negative VbyOne differential data input in area A. Lan 3	(1)
38	RX3P	4 TH Pixel Positive VbyOne differential data input in area A. Lan 3	

39	GND	Ground	
40	RX4N	5 TH Pixel Negative VbyOne differential data input in area A. Lan 4	(1)
41	RX4P	5 TH Pixel Positive VbyOne differential data input in area A. Lan 4	
42	GND	Ground	
43	RX5N	6 TH Pixel Negative VbyOne differential data input in area A. Lan 5	(1)
44	RX5P	6 TH Pixel Positive VbyOne differential data input in area A. Lan 5	
45	GND	Ground	
46	RX6N	7 TH Pixel Negative VbyOne differential data input in area A. Lan 6	(1)
47	RX6P	7 TH Pixel Positive VbyOne differential data input in area A. Lan 6	
48	GND	Ground	
49	RX7N	8 TH Pixel Negative VbyOne differential data input in area A. Lan 7	(1)
50	RX7P	8 TH Pixel Positive VbyOne differential data input in area A. Lan 7	
51	GND	Ground	

Note (1) V-by-One^R HS Data Mapping

Area	Lane	Data Stream
A	Lane 0	1, 9, 17,, 3825, 3833
	Lane 1	2, 10, 18,, 3826, 3834
	Lane 2	3, 11, 19,, 3827, 3835
	Lane 3	4, 12, 20,, 3828, 3836
	Lane 4	5, 13, 21,, 3829, 3837
	Lane 5	6, 14, 22,, 3830, 3838
	Lane 6	7, 15, 23,, 3831, 3839
	Lane 7	8, 16, 24,, 3832, 3840

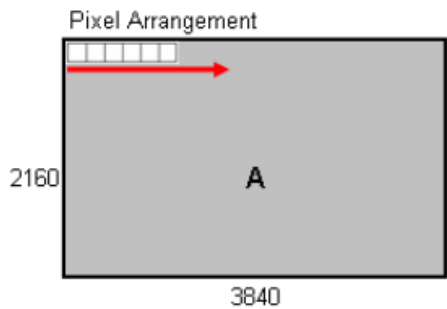
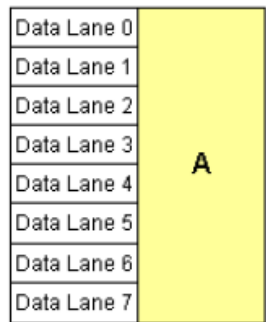
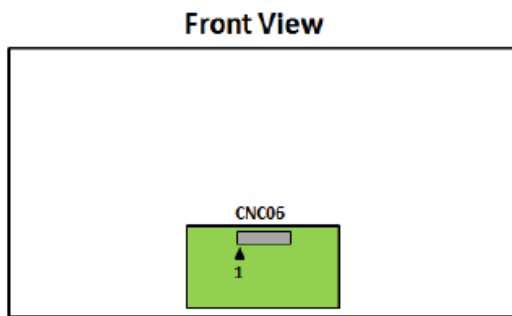

Note (2) V-by-One HS connector pin order defined as follows

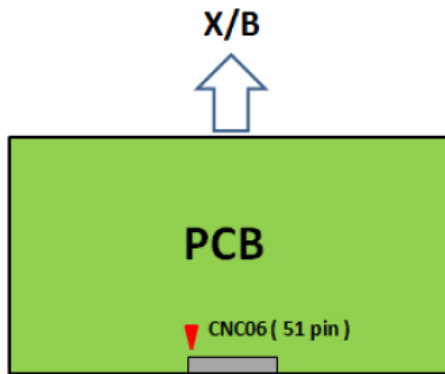

Note (4) Reserved for internal use. Please leave it open.

Note (5) Power input (+12V), Please check the current rating of FFC cable to meet the power consumption requirement.

Note (6) This pin connect to ground internal, but it could be open

Note (7) V-by-One connector Recommend Mating FFC drawing as below.

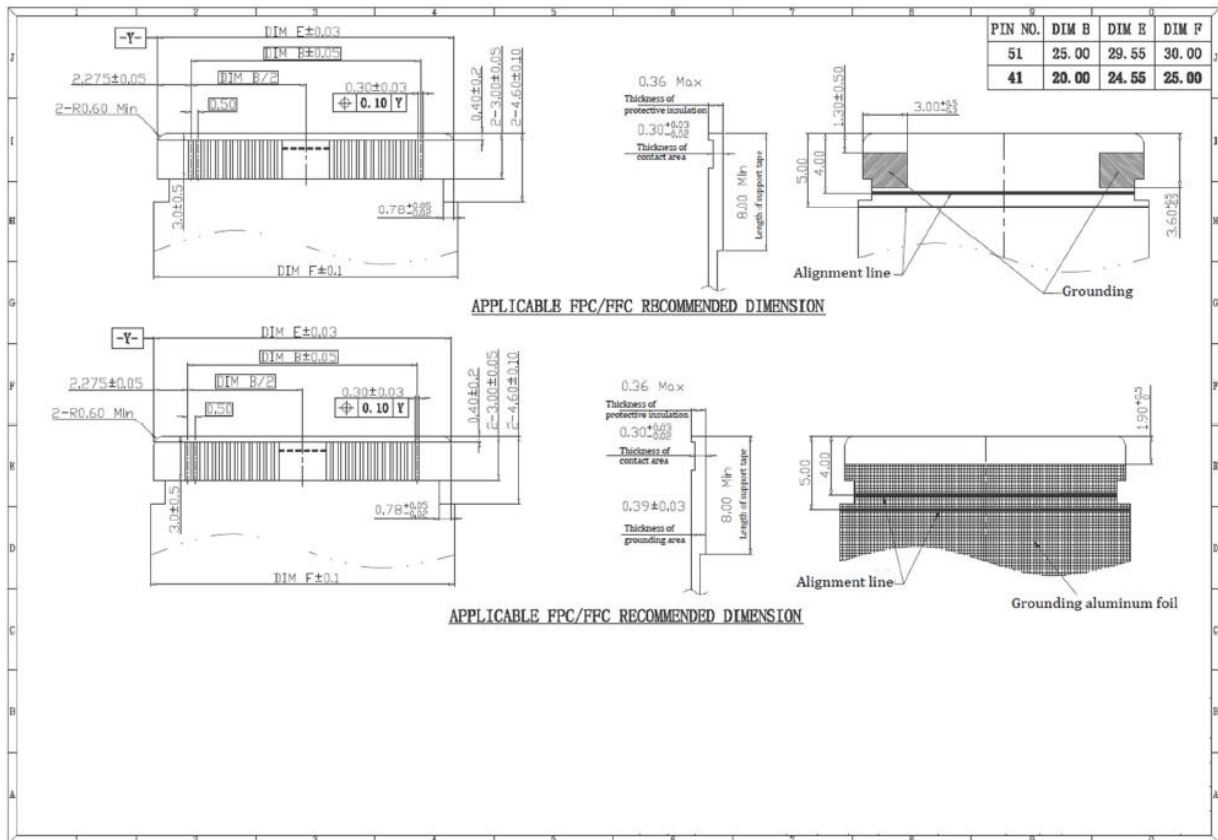

Note (8) I2C pin has internal scheme as following diagram. Customer should use additional pull-high resistor to keep the interface voltage level requirement which including Panel board loading as below.

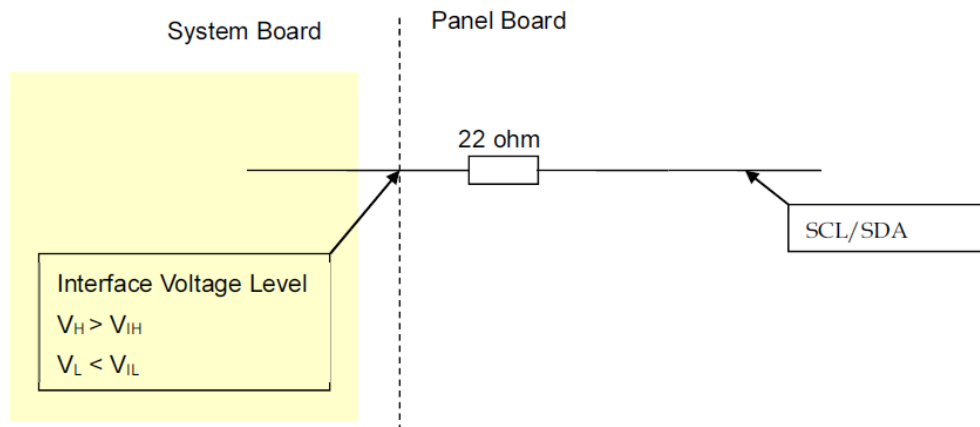

Note (9) This pin connect to ground internal, but it could be open.

2.4 Color Data Input Assignment

The brightness of each primary color (red, green and blue) is based on the 10-bit gray scale data input for the color. The higher the binary input the brighter the color. The table below provides the assignment of color versus data input.

Color		Data Signal																												
		Red										Green										Blue								
		R9	R8	R7	R6	R5	R4	R3	R2	R1	R0	G9	G8	G7	G6	G5	G4	G3	G2	G1	G0	B9	B8	B7	B6	B5	B4	B3	B2	B1
Basic Colors	Black	0	0	0	0	0	0	0	0	0	0	0	0	0	0	0	0	0	0	0	0	0	0	0	0	0	0	0	0	0
	Red	1	1	1	1	1	1	1	1	1	0	0	0	0	0	0	0	0	0	0	0	0	0	0	0	0	0	0	0	0
	Green	0	0	0	0	0	0	0	0	0	0	1	1	1	1	1	1	1	1	1	1	1	1	1	1	1	1	1	1	1
	Blue	0	0	0	0	0	0	0	0	0	0	0	0	0	0	0	0	0	0	0	0	1	1	1	1	1	1	1	1	1
	Cyan	0	0	0	0	0	0	0	0	0	0	1	1	1	1	1	1	1	1	1	1	1	1	1	1	1	1	1	1	1
	Magenta	1	1	1	1	1	1	1	1	1	1	0	0	0	0	0	0	0	0	0	0	1	1	1	1	1	1	1	1	1
	Yellow	1	1	1	1	1	1	1	1	1	1	1	1	1	1	1	1	1	1	1	1	1	0	0	0	0	0	0	0	0
	White	1	1	1	1	1	1	1	1	1	1	1	1	1	1	1	1	1	1	1	1	1	1	1	1	1	1	1	1	1
Gray Scale Of Red	Red (0) / Dark	0	0	0	0	0	0	0	0	0	0	0	0	0	0	0	0	0	0	0	0	0	0	0	0	0	0	0	0	
	Red (1)	0	0	0	0	0	0	0	0	1	0	0	0	0	0	0	0	0	0	0	0	0	0	0	0	0	0	0	0	
	Red (2)	0	0	0	0	0	0	0	1	0	0	0	0	0	0	0	0	0	0	0	0	0	0	0	0	0	0	0	0	
	:	:	:	:	:	:	:	:	:	:	:	:	:	:	:	:	:	:	:	:	:	:	:	:	:	:	:	:	:	
	:	:	:	:	:	:	:	:	:	:	:	:	:	:	:	:	:	:	:	:	:	:	:	:	:	:	:	:	:	
	:	:	:	:	:	:	:	:	:	:	:	:	:	:	:	:	:	:	:	:	:	:	:	:	:	:	:	:	:	
	Red (1021)	1	1	1	1	1	1	1	1	0	1	0	0	0	0	0	0	0	0	0	0	0	0	0	0	0	0	0	0	
	Red (1022)	1	1	1	1	1	1	1	1	1	0	0	0	0	0	0	0	0	0	0	0	0	0	0	0	0	0	0	0	
Red (1023)	1	1	1	1	1	1	1	1	1	0	0	0	0	0	0	0	0	0	0	0	0	0	0	0	0	0	0	0		
Gray Scale Of Green	Green (0) / Dark	0	0	0	0	0	0	0	0	0	0	0	0	0	0	0	0	0	0	0	0	0	0	0	0	0	0	0	0	
	Green (1)	0	0	0	0	0	0	0	0	0	0	0	0	0	0	0	0	0	0	0	1	0	0	0	0	0	0	0	0	
	Green (2)	0	0	0	0	0	0	0	0	0	0	0	0	0	0	0	0	0	0	1	0	0	0	0	0	0	0	0	0	
	:	:	:	:	:	:	:	:	:	:	:	:	:	:	:	:	:	:	:	:	:	:	:	:	:	:	:	:	:	
	:	:	:	:	:	:	:	:	:	:	:	:	:	:	:	:	:	:	:	:	:	:	:	:	:	:	:	:	:	
	:	:	:	:	:	:	:	:	:	:	:	:	:	:	:	:	:	:	:	:	:	:	:	:	:	:	:	:	:	
	Green (1021)	0	0	0	0	0	0	0	0	0	1	1	1	1	1	1	1	1	1	1	0	0	0	0	0	0	0	0	0	
	Green (1022)	0	0	0	0	0	0	0	0	0	1	1	1	1	1	1	1	1	1	1	0	0	0	0	0	0	0	0	0	
Green (1023)	0	0	0	0	0	0	0	0	0	1	1	1	1	1	1	1	1	1	1	0	0	0	0	0	0	0	0	0		
Gray Scale Of Blue	Blue (0) / Dark	0	0	0	0	0	0	0	0	0	0	0	0	0	0	0	0	0	0	0	0	0	0	0	0	0	0	0	0	
	Blue (1)	0	0	0	0	0	0	0	0	0	0	0	0	0	0	0	0	0	0	0	0	0	0	0	0	0	0	0	1	
	Blue (2)	0	0	0	0	0	0	0	0	0	0	0	0	0	0	0	0	0	0	0	0	0	0	0	0	0	0	1	0	
	:	:	:	:	:	:	:	:	:	:	:	:	:	:	:	:	:	:	:	:	:	:	:	:	:	:	:	:	:	
	:	:	:	:	:	:	:	:	:	:	:	:	:	:	:	:	:	:	:	:	:	:	:	:	:	:	:	:	:	
	:	:	:	:	:	:	:	:	:	:	:	:	:	:	:	:	:	:	:	:	:	:	:	:	:	:	:	:	:	
	Blue (1021)	0	0	0	0	0	0	0	0	0	0	0	0	0	0	0	0	0	0	0	1	1	1	1	1	1	1	1	0	
	Blue (1022)	0	0	0	0	0	0	0	0	0	0	0	0	0	0	0	0	0	0	0	1	1	1	1	1	1	1	1	0	
Blue (1023)	0	0	0	0	0	0	0	0	0	0	0	0	0	0	0	0	0	0	0	1	1	1	1	1	1	1	1	1		

Note (1) 0: Low Level Voltage · 1: High Level Voltage

2.5 Flicker (Vcom) Adjustment

(1) Adjustment Pattern:

1+2N- Sub-pixel pattern was shown as below. If customer need below pattern, please directly contact with Account FAE.

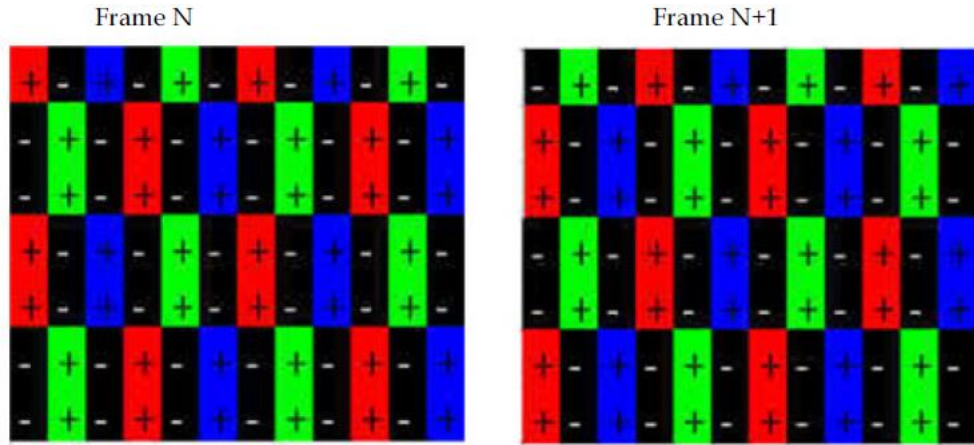

(2) Adjustment method: (Digital V-com)

Programmable memory IC is used for Digital V-com adjustment in this model. Litemax provide Auto Vcom tools to adjust Digital V-com. The detail connection and setting instruction, please directly contact with Account FAE or refer Litemax Auto V-com adjustment OI. Below items is suggested to be ready before Digital V-com adjustment in customer LCM line.

- a. USB Sensor Board.
- b. Programmable software

2.6 Input Signal Timing Specifications

The input signal timing specifications are shown as the following table and timing diagram.

($T_a = 25 \pm 2 \text{ }^\circ\text{C}$)

Signal	Item	Symbol	Min.	Typ.	Max.	Unit	Note
Frequency	Data Clock	1/Tc	70	74.25	80	MHZ	(1)
V-by-One Receiver	Intra-Pair skew		-0.3	—	0.3	UI	(2)
	Inter-pair skew		-5	—	5	UI	(3)
	Spread spectrum modulation range	F _{dkin_mod}	1/Tc-0.5%	—	1/Tc+0.5%	MHZ	(4)
	Spread spectrum modulation frequency	F _{SSM}	—	—	30	KHZ	

Timing Spec For QFHD Frame Rate = 50Hz

Signal	Item	Symbol	Min.	Typ.	Max.	Unit	Note	
Frame rate	2D mode	Fr	47	50	53	Hz	(5),(6)	
Horizontal Frequency		Fh	122.8	135	140	KHz		
Vertical Active Display Term (8 Lane,3840X2160 Active Area)	2D Mode	Total	Tv	2200	2700	2790	Th	Tv=Tvd+Tvb
		Display	Tvd	2160			Th	
		Blank	Tvb	40	540	630	Th	
Horizontal Active Display Term (8 Lane,3840X2160 Active Area)	2D Mode	Total	Th	530	550	570	Tc	Th=Thd+Thb
		Display	Thd	480			Tc	
		Blank	Thb	50	70	90	Tc	

Timing Spec For QFHD Frame Rate = 60Hz

Signal	Item	Symbol	Min.	Typ.	Max.	Unit	Note	
Frame Rate	2D Mode	F _r	57	60	63	Hz	(5),(6)	
Horizontal Frequency		F _h	122.8	135	140	KHz		
Vertical Active Display Term (8 Lane,3840X2160 Active Area)	2D Mode	Total	Tv	2200	2250	2790	Th	Tv=Tvd+Tvb
		Display	Tvd	2160			Th	
		Blank	Tvb	40	90	630	Th	
Horizontal Active Display Term (8 Lane,3840X2160 Active Area)	2D Mode	Total	Th	530	550	570	Tc	Th=Thd+Thb
		Display	Thd	480			Tc	
		Blank	Thb	50	70	90	Tc	

Note (1) Please make sure the range of pixel clock has follow the below equation :

$$F_{clk_{in}}(\max) \geq Fr \times Tv \times Th$$

$$Fr \times Tv \times Th \geq F_{clk_{in}}(\min)$$

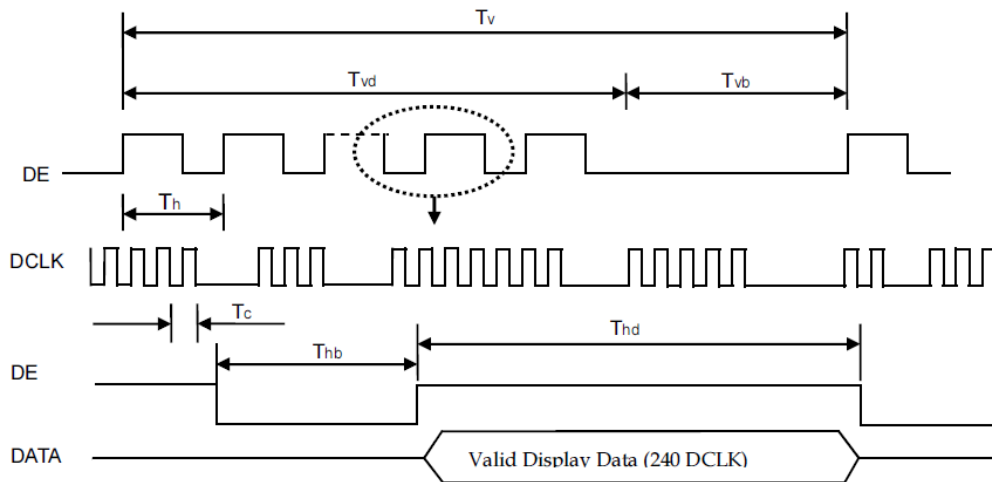

Note (2) VbyOne HS Intra-pair skew

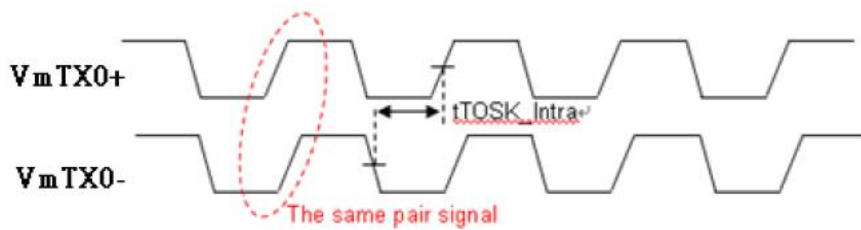

Note (3) VbyOne HS Inter-pair skew.

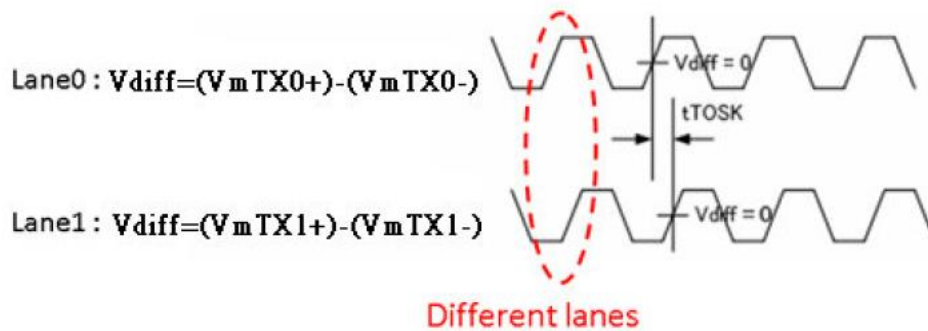

Note (4) The SSCG (Spread spectrum clock generator) is defined as below figures.

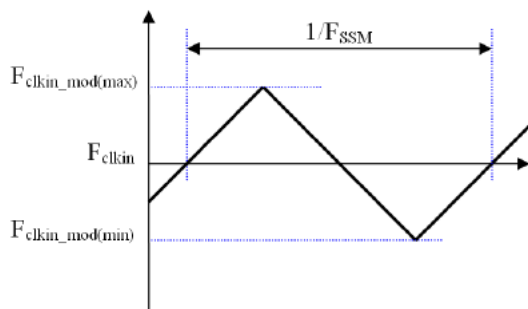

Note (5) For converter reference signals, the frame-to-frame jitter of the input frame rate is defined as the above figures. $FR_n = FR_{n-1} \pm 1.8\%$

Note (6) For converter reference signals, The setup of the frame rate jitter > 1.8% may result in the cosmetic LED backlight symptom.

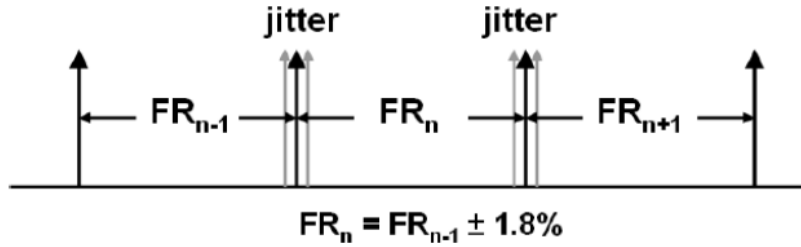

2.7 Timing Diagram

V By One Signal Timing Diagram

The eye diagram is measured by the oscilloscope and receiver CDR characteristic must be emulated.

PLL bandwidth : 40MHz

Damping factor : 1.4

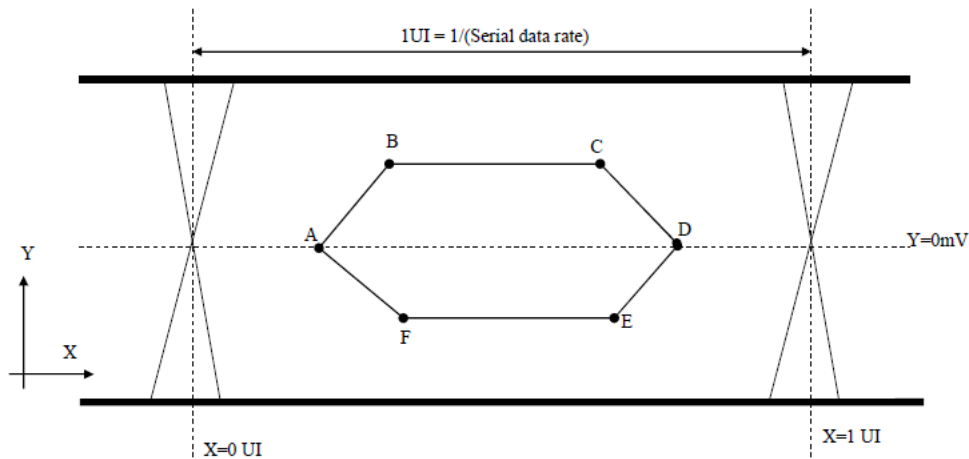

Table 1 Eye Mask Specification

	X [UI]	Y [mV]	Note
A	0.25	0	(1)
B	0.3	50	(1)
C	0.7	50	(1)
D	0.75	0	(1)
E	0.7	-50	(1)
F	0.3	-50	(1)

Note (1) Input levels of V-by-One HS signals are comes from "V-by-One HS Stander Ver.1.4"

CMPI Signal Timing Diagram

CMPI AC Electrical Characteristics

Parameter	Symbol	Min.	Typ.	Max.	Unit	Condition
Effective Veye Rising Time	tREYE	0.20	-	-	UI	
Effective Veye Falling Time	tFEYE	0.20	-	-	UI	
Effective Veye Level	VEYE	75	-	-	mV	
CMPI Clock	1UI		0.644		ns	

Note (1) CMPI EYE diagram must be in above spec within any pattern. If your application is not in our spec., Litemax can not guarantee display and function normal.

Note (2) Eye timing diagram

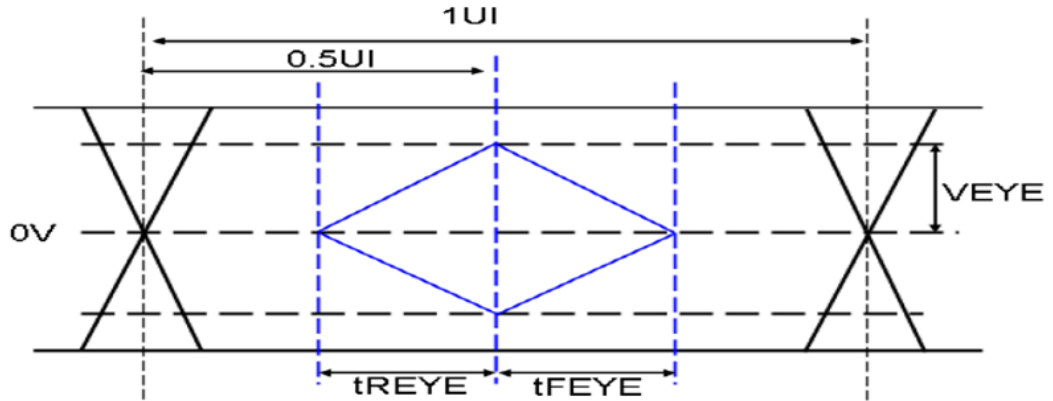

Note (3) Measure point: C0_X P/N

Note (4) Recommended FFC drawing

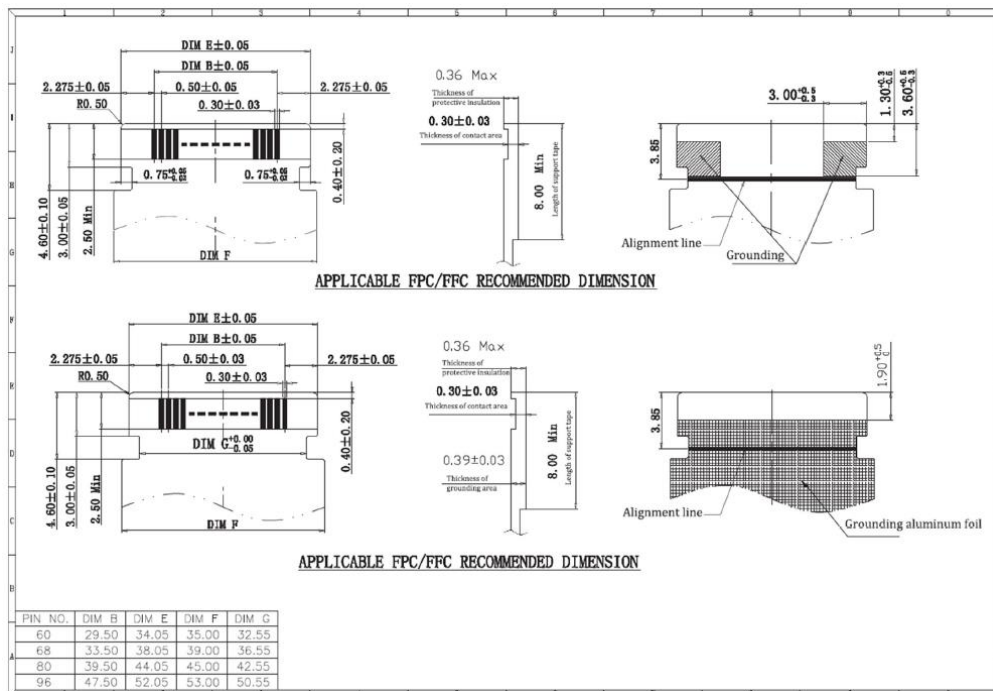

Byte Length And Color Mapping Of V-By-One HS

Packer input & Unpacker output		30bpp RGB (10bit)
Byte 0	D[0]	R[2]
	D[1]	R[3]
	D[2]	R[4]
	D[3]	R[5]
	D[4]	R[6]
	D[5]	R[7]
	D[6]	R[8]
	D[7]	R[9]
Byte 1	D[8]	G[2]
	D[9]	G[3]
	D[10]	G[4]
	D[11]	G[5]
	D[12]	G[6]
	D[13]	G[7]
	D[14]	G[8]
	D[15]	G[9]
Byte 2	D[16]	B[2]
	D[17]	B[3]
	D[18]	B[4]
	D[19]	B[5]
	D[20]	B[6]
	D[21]	B[7]
	D[22]	B[8]
	D[23]	B[9]
Byte 3	D[24]	X
	D[25]	X
	D[26]	B[0]
	D[27]	B[1]
	D[28]	G[0]
	D[29]	G[1]
	D[30]	R[0]
	D[31]	R[1]

2.8 Power On/Off Sequence

To prevent a latch-up or DC operation of LCD module, the power on/off sequence should be as the diagram below. (Ta = 25 ± 2 °C)

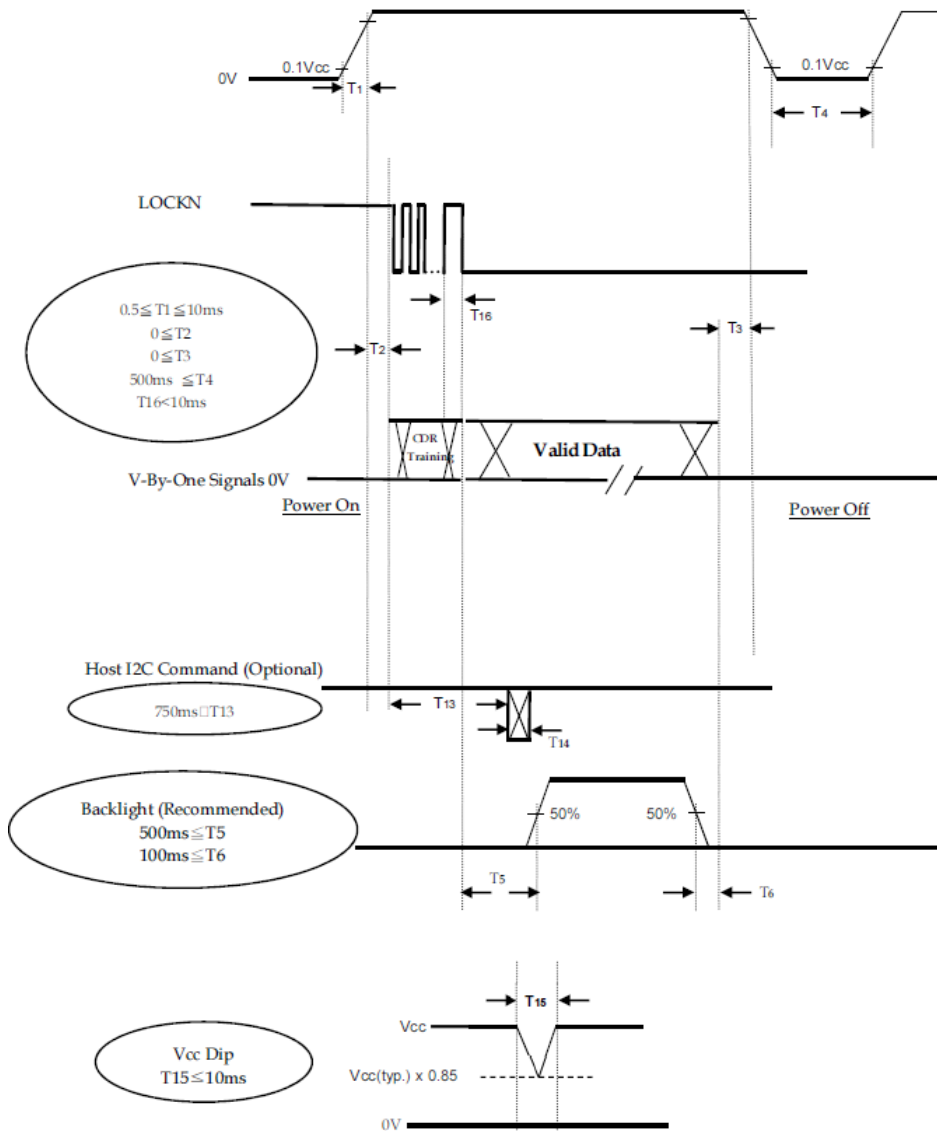

Note (1) The supply voltage of the external system for the module input should follow the definition of Vcc.

Note (2) Apply the LED voltage within the LCD operation range. When the backlight turns on before the LCD operation or the LCD turns off before the backlight turns off, the display may momentarily become abnormal screen.

Note (3) In case of Vcc is in off level, please keep the level of input signals on the low or high impedance besides LOCKN. If T2 < 0, that maybe cause electrical overstress failure.

Note (4) T4 should be measured after the module has been fully discharged between power off and on period.

Note (5) Interface signal shall not be kept at high impedance when the power is on.

Note (6) Vcc have to be decayed smoothly when power-off.

Note (7) When the I2C Command is after backlight turns on, the display may momentarily become abnormal screen.

Note (8) T16, V-by-One signals shall be stabilized and follows timing specification which defined by section 2.6 & 2.7

3 Optical Specification

Item		Symbol	Condition	Min.	Typ.	Max.	Unit	Note
Color chromaticity	Red	Rx	$\theta_x=0$ $\theta_y=0$ CA-410	0.623	0.653	0.683	-	Test Mode: (2) (3)
		Ry		0.303	0.333	0.363	-	
	Green	Gx		0.283	0.313	0.343	-	
		Gy		0.577	0.607	0.637	-	
	Blue	Bx		0.115	0.145	0.175	-	
		By		0.025	0.055	0.085	-	
	White	Wx		0.255	0.285	0.315	-	
		Wy		0.263	0.293	0.323	-	
Center Luminance of White		Lc	$\theta_x=0$ $\theta_y=0$	2250	2500	3250	cd/m ²	
Uniformity		Lu	CA-410		86		%	
Contrast Ratio		CR	$\theta_x=0$	5400:1	6000:1		-	Test Mode: (4)
Color Saturation		NTSC	$\theta_y=0$ Klein K-10		83		%	
Viewing Angle	Horizontal	θ_{x+}	CR \geq 10		89		Deg	Test Mode: (1)
		θ_{x-}			89			
	Vertical	θ_{y+}			89			
		θ_{y-}			89			

Test Mode :

(1) Definition of Viewing Angle (θ_x , θ_y):

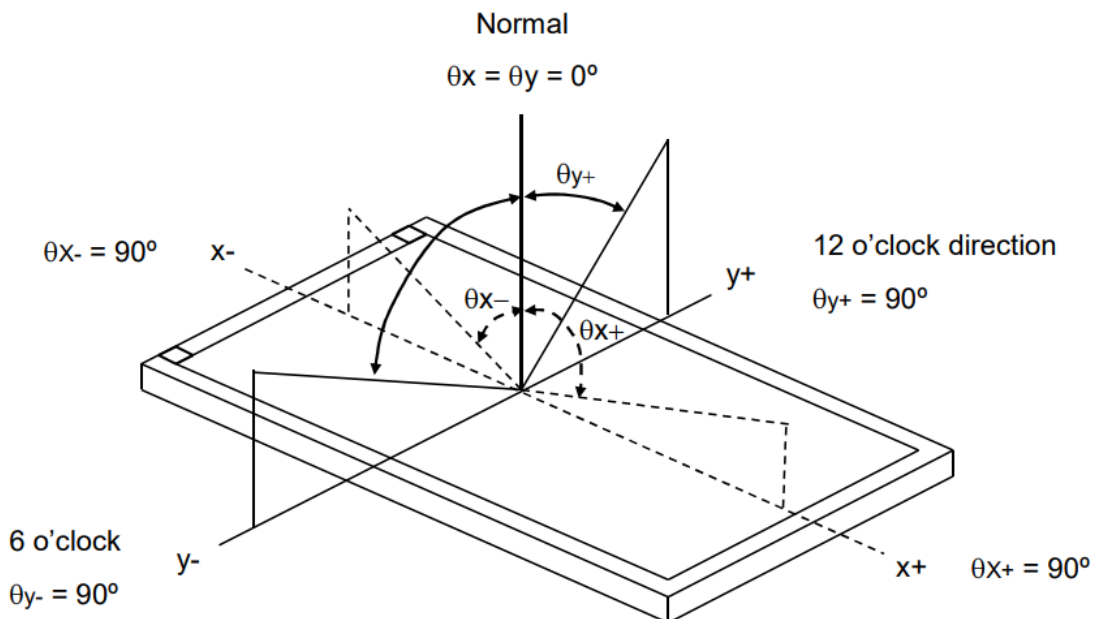

(2) Definition of Test Point:

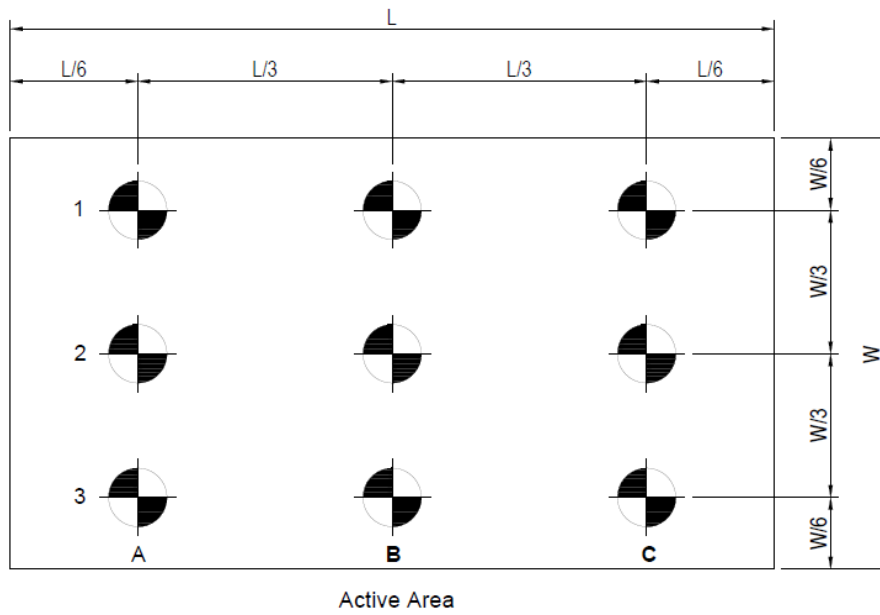

(3) CA-410 Measurement Setup:

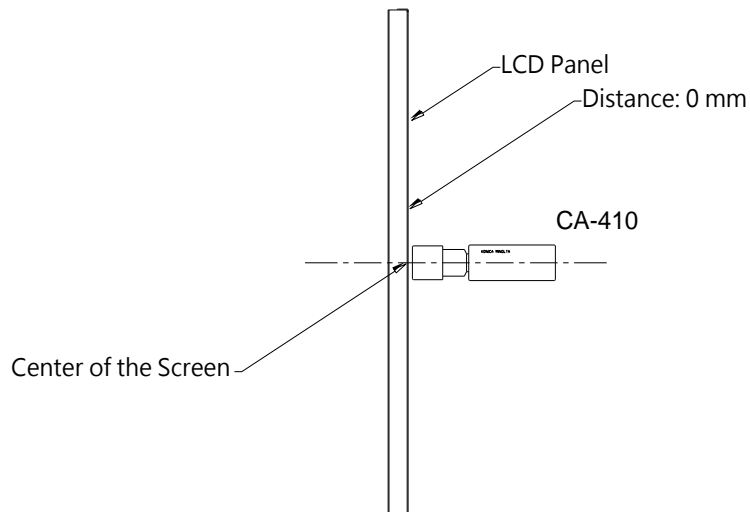

(4) Klein K-10 Measurement Setup:

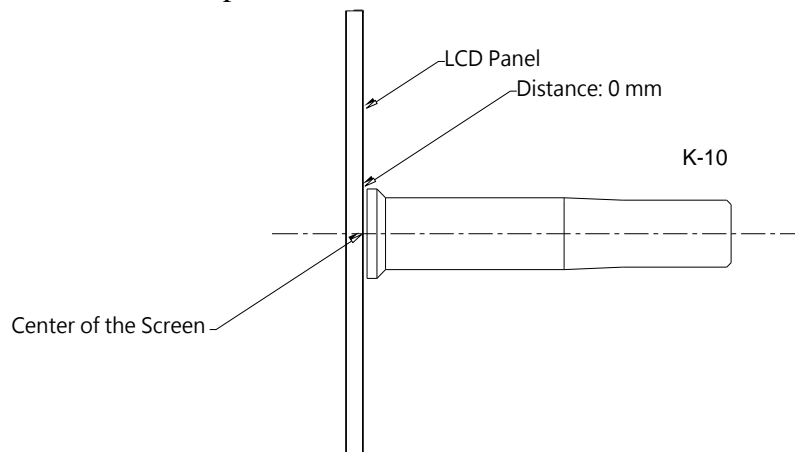

4 LED Driving Board Specifications

This specification is applied to LED converter unit for 5500-I 2500nits LED backlight.

4.1 Operating Characteristics

Item	Symbol	Condition	MIN.	TYP.	MAX.	Unit	Remark
Input Voltage	V _{in}		22.0	24.0	26.0	V	
Input Current (High Brightness)	I _{inH}	Brightness = 100%	5.54	5.07	4.68	A	(1)
Input Power Consumption	P _{in}	Brightness = 100%	-----	121.6	-----	W	
LED Current (High Brightness)	I _{outH}	Brightness = 100%	-----	1.09	-----	A	J2
			-----	2.19	-----	A	J7 · J8
Working Frequency	W_Freq	Brightness = 100%	-----	400	-----	KHZ	
Brightness Control	DC mode						
	V _{adj}	Connection of Voltage	0.2	-----	4.8	V	(2)
	PWM mode						
	PWM	Connect to PWM	0	-----	100	%	(3)
Freq	-----		200	-----	Hz	(4)	
ON/OFF Control	V _{on}	Normal Operation	2	-----	5	V	
	V _{off}		0	-----	0.8	V	
Output Voltage	V _{out}	Brightness = 100%	-----	33.44	33.49	V	J2
			-----	33.44	33.49	V	J7 · J8
Efficiency	η	Brightness = 100%	-----	90.1	-----	%	(5)

Remark:

- (1) This data is based on the testing result of practical input voltage, I_{in} is measured by related V_{in}. (min, typ, max). If the voltage is increased, the current will decrease. If the voltage is decrease, the current will increase.
- (2) Max brightness at V_{adj}=0.2V. Min brightness at V_{adj}=4.8V.
- (3) Max dimming ratio = 1:100.
- (4) Frequency can be adjusted in accordance with demand(120Hz minimum, or lights will be flickering)
- (5) $\eta_{max} = V_{out(max)} * I_{outH(max)} / V_{in(max)} * I_{inH(min)}$
 $\eta_{min} = V_{out(min)} * I_{outH(min)} / V_{in(min)} * I_{inH(max)}$

4.2 Connector Socket

Input Connector: CN1 (JST B10B-PH-K-S or Compatible)

PIN No	Symbol	Description
1	Vin	DC+
2	Vin	DC+
3	Vin	DC+
4	Vin	DC+
5	Vin	DC+
6	GND	Ground
7	GND	Ground
8	GND	Ground
9	GND	Ground
10	GND	Ground

DC or PWM Connector :CN2

PIN NO	Symbol	Description
1	DC	Close pin 1,2 LED driver is DC dimming
2	GND	Close pin 2,3 LED driver is PWM dimming
3	PWM	

Note: If you use CN2 to set DC/PWM, please NC the pin1 of CN3.

Input Connector :CN3 (JST B3B-PH-K-S or Compatible)

PIN No	Symbol	Description
1	CL	PWM or DC selection
2	Control	ON/OFF Control
3	Brightness	Brightness Control
4	GND	Ground

Note: Pin1 is dimming method control pin, Low → DC dimming, High → PWM dimming.
If pin1 is be used, please NC CN2.

Output Connector : J1,J2, J7,J8(JST S2B-EH or Compatible)

PIN NO	Symbol	Description
1	Output	LED High Voltage(+)
2	Output	LED Low Voltage (-)

4.3 Mechanical Characteristics

Dimension: 160 x 90 x 12.5mm

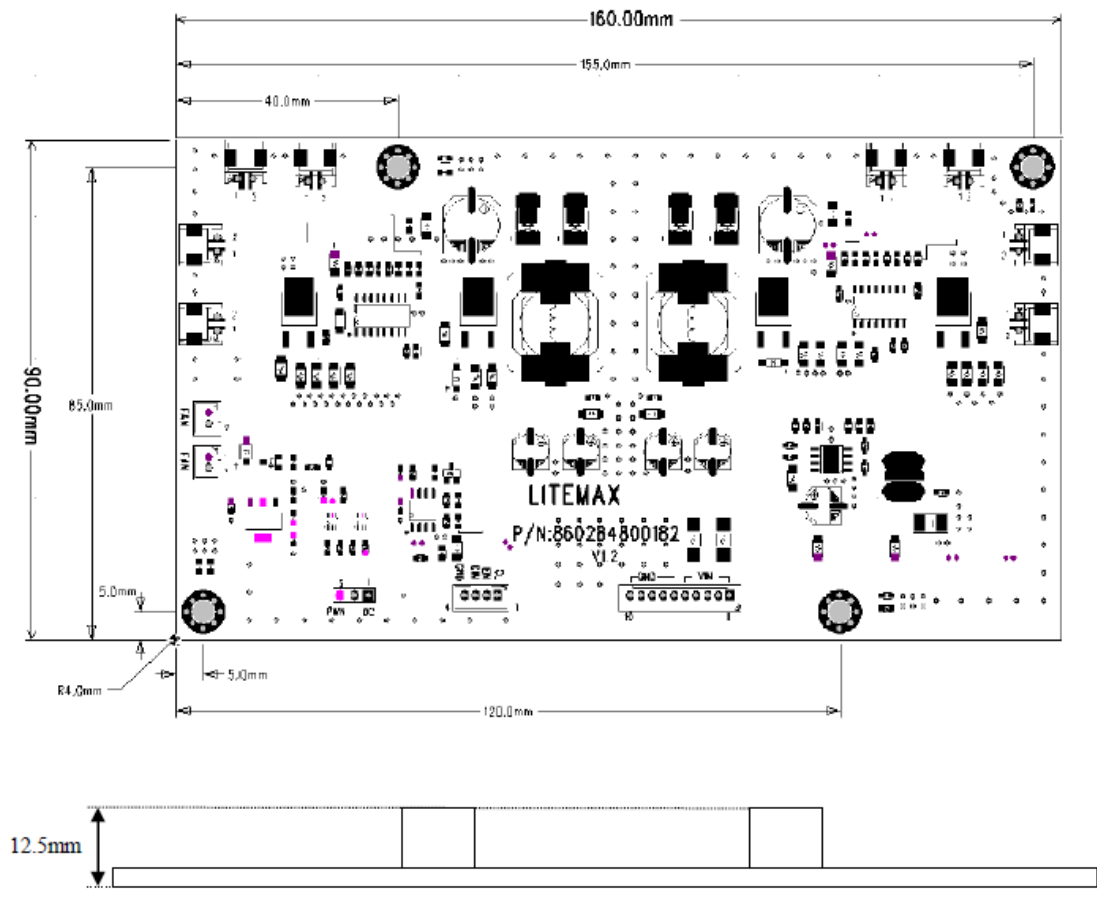

5 Mechanical Drawing

Unit:mm

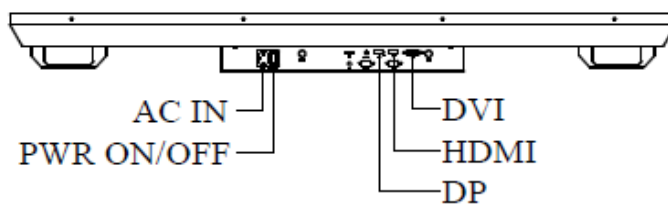
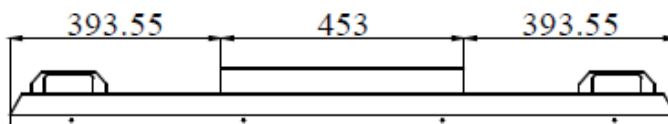
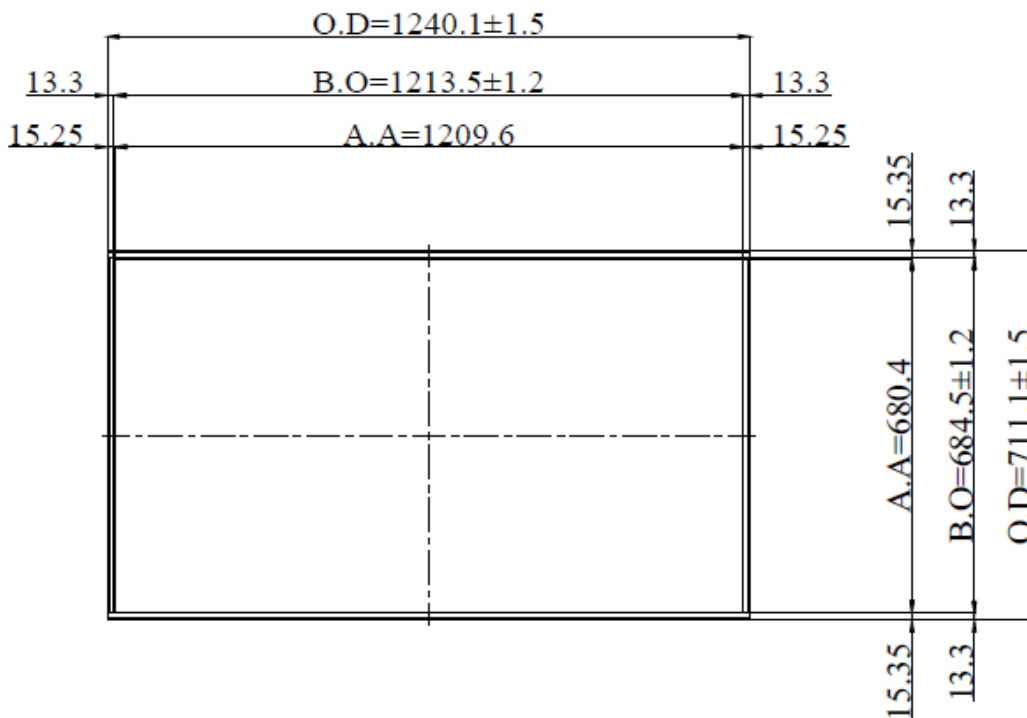
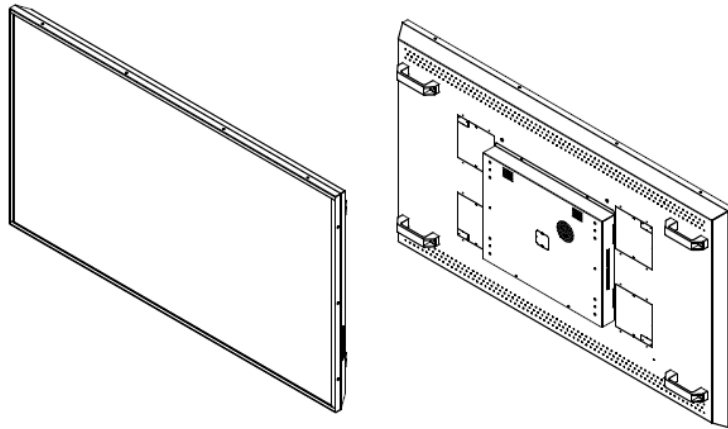

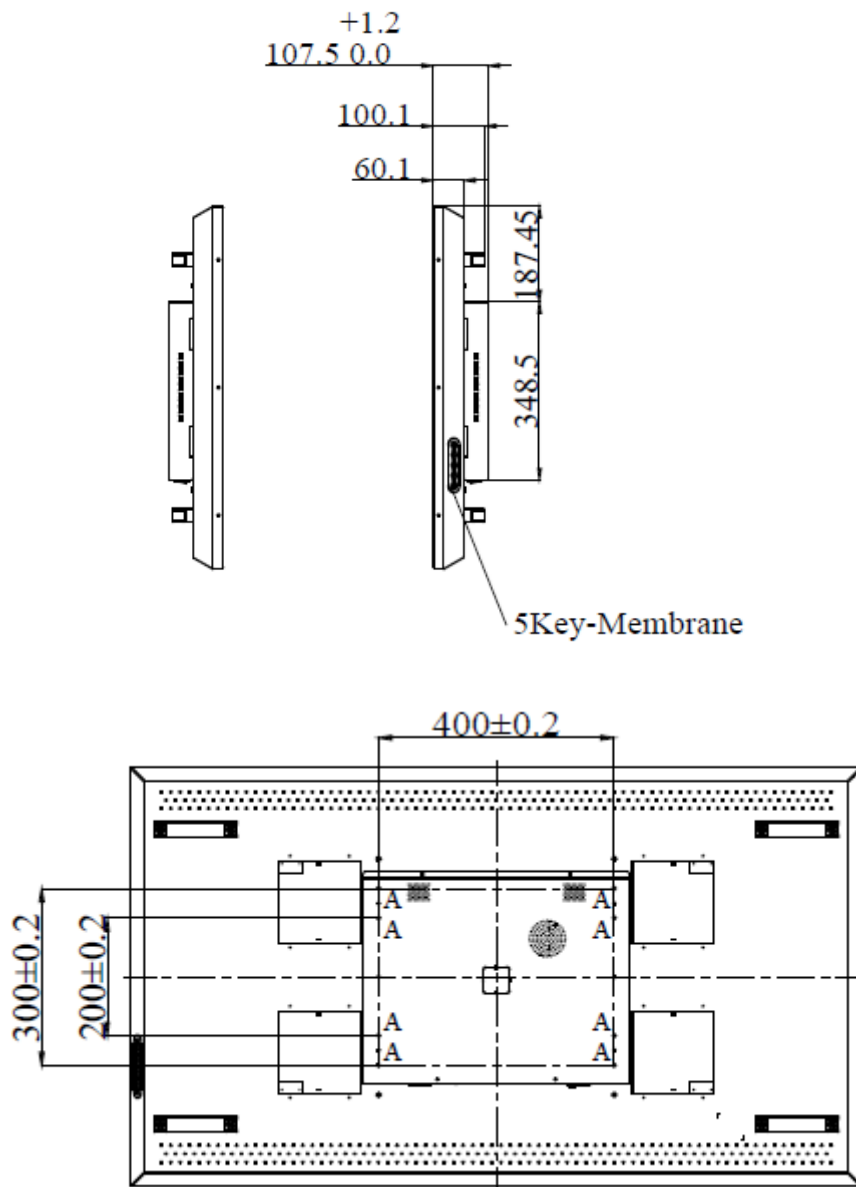

NOTE :

O.D. : OUTLINE DIMENSION

B.O. : BEZEL OPENING

A.A. : ACTIVE AREA

A:8-M6_USER HOLE_MAX Depth=12mm

6 AD9131DHP Board & OSD Functions

We developed this A/D board to support industrial high brightness and commercial applications. This A/D board has many functions. It has an external luminance sensor as an option, or optional VR button to control brightness, fan rotation and RS232. Rev.2 is European RoHS compliant.

6.1 General Description

- Max resolution up to UHD (4096x2160)
- Support V-By-one or e-DP panel
- DVI operates up to 165M Hz
- One ultra-reliable dual-link DVI input(4K2K@30Hz)
- One HDMI(HDMI 2.0) input(4K2K@60Hz)
- One display port input (DP 1.2a) (4K2K@60Hz)
- V-by-One or e-DP interface
- Support panel DC5V or 3.3V, 12V output
- External fan control by software
- OSD control
- Inverter analog or PWM dimming control
- External V.R. brightness control (Optional)
- External light sensor brightness control (Optional)
- External RS232 control (Optional)
- Input power 24V DC or 12V DC (24V DC power input is optional)

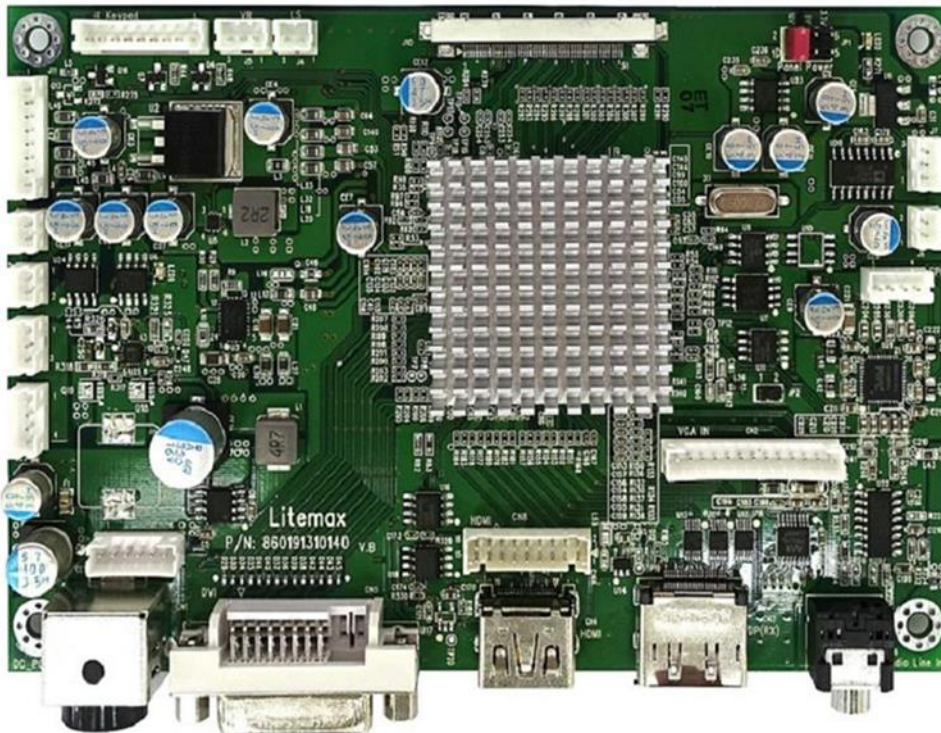

6.2 Outline Dimensions

AD9131 150mm x 100mm

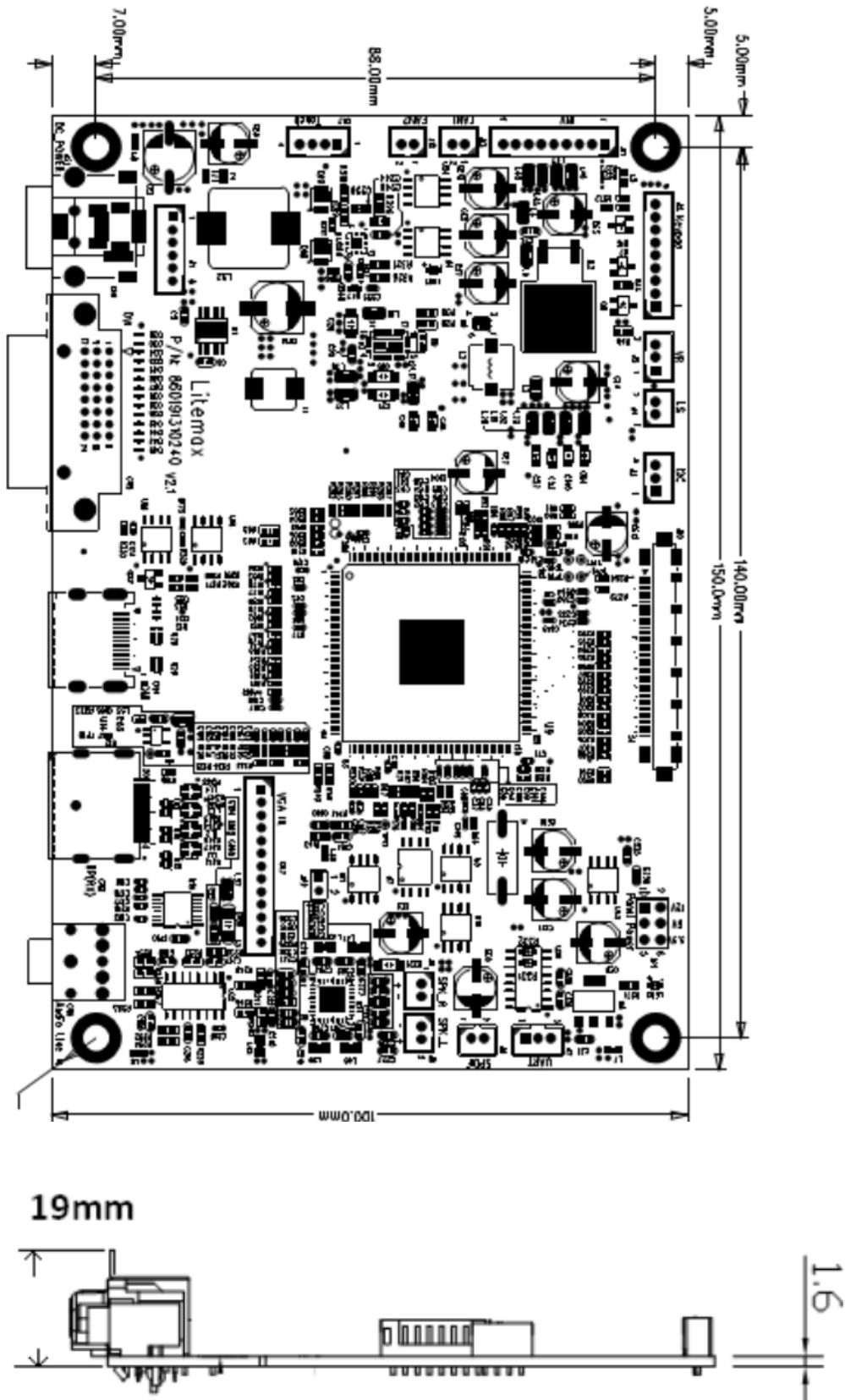

6.3 AD9131DHP Board Pin Define

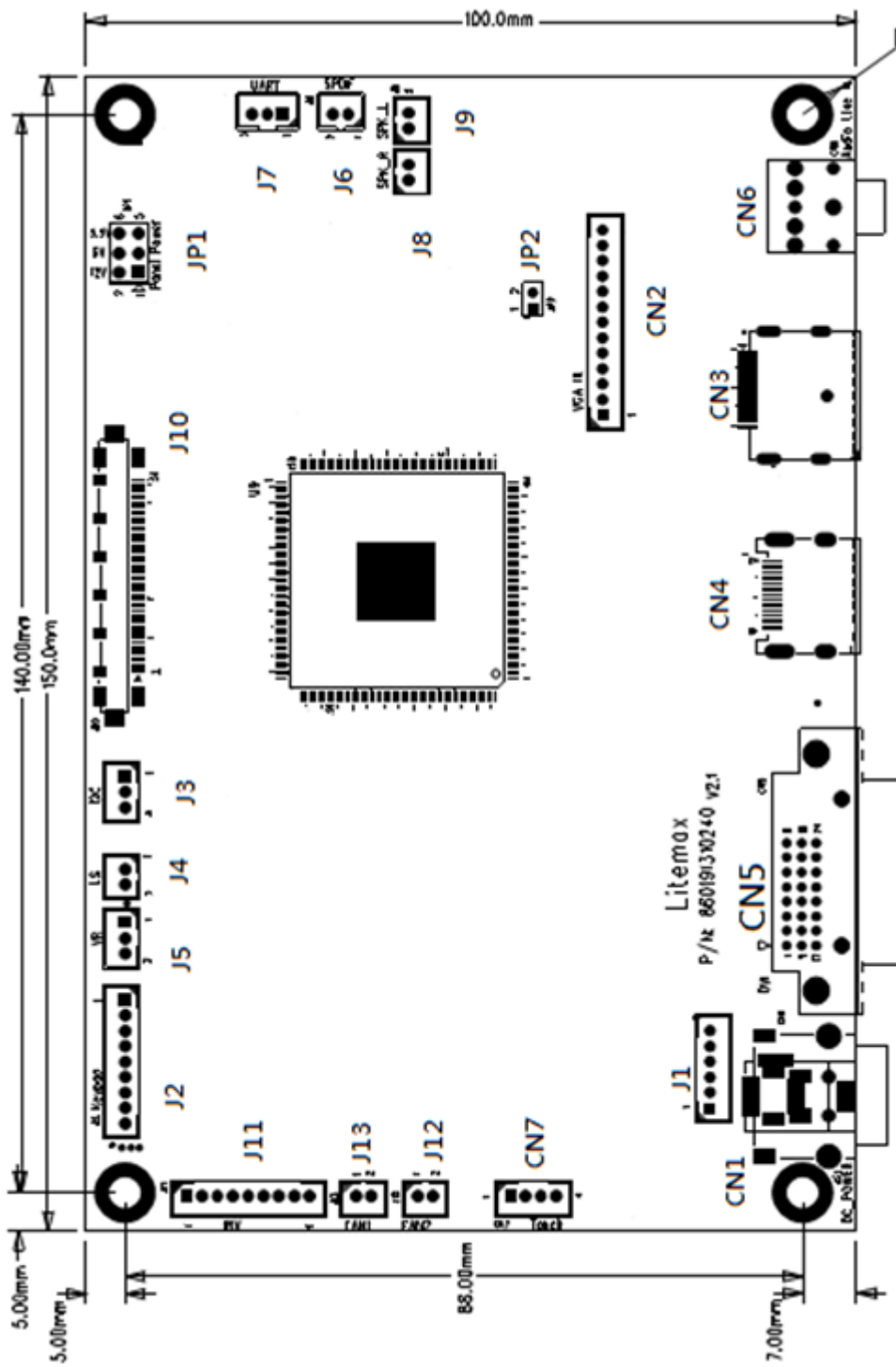

J10: Panel (V-By-one or e-DP) connector

Pin No.	Function	Pin No.	Function
1	PANEL-VCC	27	GND
2	PANEL-VCC	28	RX0N
3	PANEL-VCC	29	RX0P
4	PANEL-VCC	30	GND
5	PANEL-VCC	31	RX1N
6	PANEL-VCC	32	RX1P
7	PANEL-VCC	33	GND
8	PANEL-VCC	34	RX2N
9	NC	35	RX2P
10	GND	36	GND
11	GND	37	RX3N
12	GND	38	RX3P
13	GND	39	GND
14	GND	40	RX4N
15	eDP_HPDI	41	RX4P
16	AUXTX_P1	42	GND
17	AUXTX_N1	43	RX5N
18	P_SDA	44	RX5P
19	P_SCL	45	GND
20	NC	46	RX6N
21	eDP_HPDI	47	RX6P
22	LD_EN	48	GND
23	AUXTX_P0	49	RX7N
24	AUXTX_N0	50	RX7P
25	HTPDN	51	GND
26	LOCKN		

CN5: DVI-D Input Connector (24pin)

Pin No.	Function	Pin No.	Function	Pin No.	Function
1	T.M.D.S. Data2-	9	T.M.D.S. Data1-	17	T.M.D.S. Data0-
2	T.M.D.S. Data2+	10	T.M.D.S. Data1+	18	T.M.D.S. Data0+
3	T.M.D.S. Data2/4 Shield	11	T.M.D.S. Data1/3 Shield	19	T.M.D.S. Data0/5 Shield
4	T.M.D.S. Data4-	12	T.M.D.S. Data3-	20	T.M.D.S. Data5-
5	T.M.D.S. Data4+	13	T.M.D.S. Data3+	21	T.M.D.S. Data5+

6	DDC Clock	14	+5V Power	22	T.M.D.S. Clock Shield
7	DDC Data	15	Ground (for +5V)	23	T.M.D.S. Clock+
8	Vertical SYNC.	16	Hot Plug Detect	24	T.M.D.S. Clock-

CN4: HDMI Connector (19pin HDMI)

Pin No.	Function	Pin No.	Function	Pin No.	Function
1	T.M.D.S. Data2+	9	T.M.D.S. Data0-	17	GND
2	Shield	10	T.M.D.S. Clock+	18	HDMI 5V
3	T.M.D.S. Data2-	11	Shield	19	Hot Plug Detect
4	T.M.D.S. Data1+	12	T.M.D.S. Clock-		-
5	Shield	13	CEC		
6	T.M.D.S. Data1-	14	NC		
7	T.M.D.S. Data0+	15	HDMI_SCL		
8	Shield	16	HDMI_SDA		

CN3: DISPLAY PORT Connector (20pin DP)

Pin No.	Function	Pin No.	Function
1	LAN_C_D3N	11	GND
2	GND	12	ML_LANE0_P
3	LAN_C_D3P	13	GND
4	ML_LANE2_N	14	GND
5	GND	15	AUX_CH_P
6	ML_LANE2_P	16	GND
7	ML_LANE1_N	17	AUX_CH_N
8	GND	18	Hot plug detect
9	ML_LANE1_P	19	GND
10	ML_LANE0_N	20	DP +5V

CN6: Audio Jack in

Pin No.	Function	Pin No.	Function
1	GND	2	LINE IN R
3	GND	4	GND
5	LINE IN L		

CN1: Power DIN(24V or 12V)

Pin No.	Function	Pin No.	Function
1	DC24V or DC12V (Note 1)	2	DC24V or DC12V (Note 1)
3	GND	4	GND

CN1: Power Jack (24V or 12V)

Pin No.	Function	Pin No.	Function
1	DC24V or DC12V (Note 1)	2	GND
3	GND		

J1: Power input connector (6 pin 2.0mm)

Pin No.	Function	Pin No.	Function
1	DC24V or DC12V (Note 1)	2	DC24V or DC12V (Note 1)
3	DC24V or DC12V (Note 1)	4	GND
5	GND	6	GND

Note 1: Power input has two different versions, 12V power input version and 24V input version don't mistake.

CN7: Power out connector (5V/12V)(4PIN 2.0mm)

Pin No.	Function	Pin No.	Function
1	DC5V	2	GND
3	DC12V	4	GND

J11: Inverter Connector (8PIN 2.0mm)

Pin No.	Symbol	Description	Pin No.	Symbol	Description
1	DC/PWM	DC/PWM SEL	5	GND	GND
2	ON/OFF	Backlight ON/OFF	6	GND	GND
3	BRIGHT	Dimming adjust	7	DC12V	Input DC12V
4	GND	GND	8	DC12V	Input DC12V
9	DC12V	Input DC12V			

J13,J12: FAN (2PIN 2.0mm)

Pin No.	Function	Pin No.	Function
1	FAN(+)	2	GND

J2: Key Pad (9PIN 2.0mm)

Pin No.	Function	Pin No.	Function
1	POWER KEY	6	MENU KEY
2	GREEN LED	7	AUTO KEY
3	RED LED	8	GND
4	DOWN KEY	9	GND
5	UP KEY		

J5: VR connector (3PIN 2.0mm)

Pin No.	Function	Pin No.	Function
1	DC 3.3V	2	VR OUT
3	GND		

J4: Ambient (2PIN 2.0mm)

Pin No.	Function	Pin No.	Function
1	DC 3.3V/DC 5V	2	Sensor Out

JP1: PANEL VCC (3PIN 2.54mm)

Pin No.	Function	Pin No.	Function
1-2	12V	5-6	3.3V
3-4	5V		

J8& J9: Speaker Connector (2PIN 2.0mm)

Pin No.	Function	Pin No.	Function
1	SPK+	2	SPK-

J7: UART Connector (RS232 IN) (3PIN 2.0mm)

Pin No.	Function	Pin No.	Function
1	TXD	2	RXD
3	GND		

J3: I2C Connector (3PIN 2.0mm)

Pin No.	Function	Pin No.	Function
1	SDA	2	SCL
3	GND		

J6: SPDIF (2PIN 2.0mm)

Pin No.	Function	Pin No.	Function
1	SPDIF_OUT	2	GND

JP2: EDID (2PIN 2.0mm)





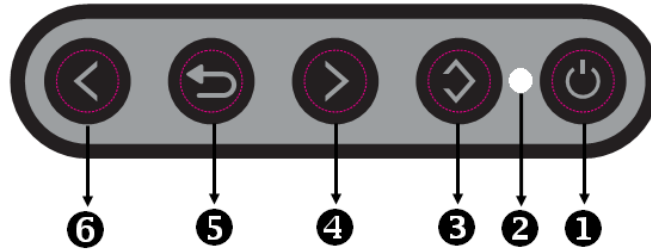

Pin No.	Function	Pin No.	Function
1	EEROM Write protect	2	GND

When need to rewrite EEROM EDID , short two pin .

6.4 OSD Function

MEMBRANE CONTROL BUTTOM



- 1**  **Key:** (Power) function key
Press the power switch will turn the monitor on.
Press it again to turn the monitor off.
- 2**  **LED Status:** Power ON-Green / Power off-No.
- 3**  **Key:** (Menu + Selection Right + Enter) function key
Press this button to the OSD “main menu”. And then press this button go to the “Selection Right” function, and press again this button to “Enter”.
- 4**  **Key:** (Menu + Selection Up + Increase) function key
Press this button to the OSD “main menu”. And then press this button go to the “Selection Up” function, and press again this button to adjustment value “Increase”.
- 5**  **Key:** (Menu + Exit) function key
Enter to the OSD adjustment menu. It also used for go back to previous menu for sub-menu.
- 6**  **Key:** (Menu + Selection Down + Decrease) function key
Press this button to the OSD “main menu”. And then press this button go to the “Selection Down” function, and press again this button to adjustment value “Decrease”.

Screen Adjustment Operation Procedure

1. Entering the screen adjustment

The setting switches are normally at stand-by. Push the **Menu Key** once to display the main menu of the screen adjustment. The adjustable items will be displayed in the main menu.

2. Entering the settings

Use the **Down Key**  and **Up Key**  buttons to select the desired setting icon and push the SELECT button to enter sub-menu.

3. Change the settings

After the sub-menu appears, use the **Down Key**  and **Up Key**  buttons to change the setting values.

4. Save

After finishing the adjustment, push the  button to memorize the setting.

5. Return & Exit the Main Menu

Exit the screen adjustment; push the “MENU” button. When no operation is done around 30 sec (default OSD timeout), it goes back to the stand-by mode and no more switching is accepted except MENU to restart the setting.

6.5 OSD Menu

By pressing the “menu” button, you will see the below picture. Across from timing you will see resolution, frequency, and V-frequency of the panel. These cannot be altered by the user.

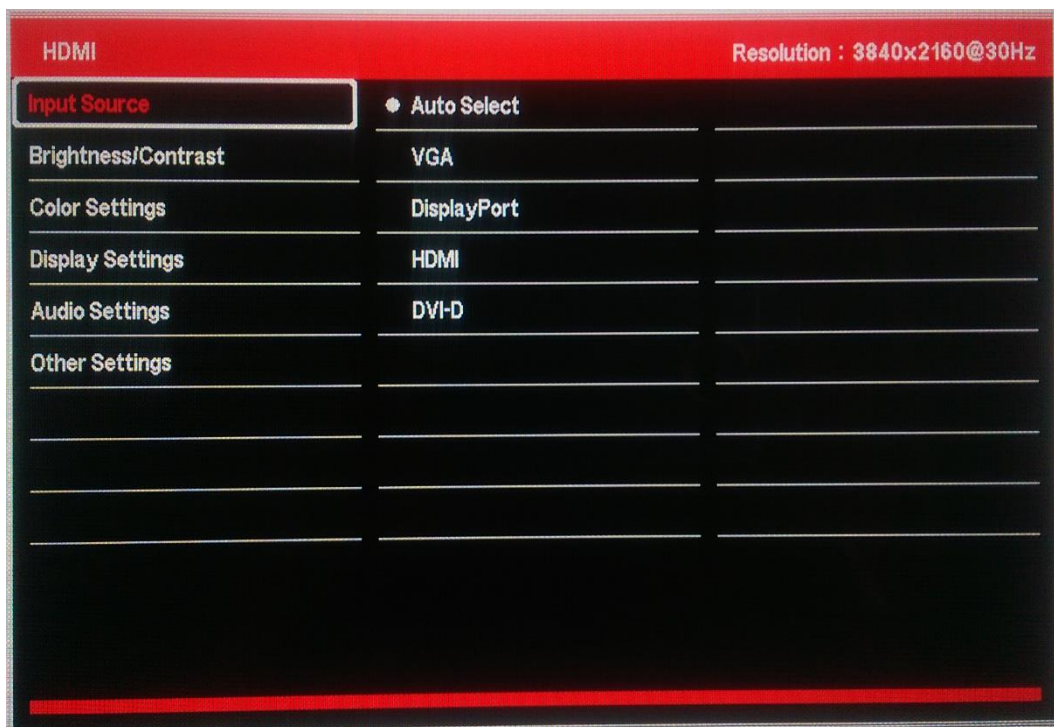

7 Precautions

7.1 Handling and Mounting Precautions

- (1) The module should be assembled into the system firmly by using every mounting hole. Do not apply rough force such as bending or twisting to the LCD during assembly.
- (2) You should consider the mounting structure so that uneven force (ex. Twisted stress, Concentrated stress) is not applied to the module. And the case on which a module is mounted should have sufficient strength so that external force is not transmitted directly to the LCD module.
- (3) While assembling or installing LCD modules, it can only be in the clean area. The dust and oil may cause electrical short or damage the polarizer.
- (4) Use fingerstalls or soft gloves in order to keep display clean during the incoming inspection and assembly process.
- (5) Do not press or scratch the surface harder than a HB pencil lead on the panel because the polarizer is very soft and easily be scratched.
- (6) Please attach the surface transparent protection film to the surface in order to protect the polarizer. Transparent protection film should have sufficient strength in order to the resist external force.
- (7) When the transparent protection film is peeled off, static electricity is generated between the film and polarizer. This should be peeled off slowly and carefully by people who are electrically grounded and with well ion-blown equipment or in such a condition, etc.
- (8) If the surface of the polarizer is dirty, please clean it by some absorbent cotton or soft cloth. Do not use Ketone type materials (ex. Acetone), Ethyl alcohol, Toluene, Ethyl acid or Methyl chloride. It might permanently damage the polarizer due to chemical reaction.
- (9) Wipe off water droplets or oil immediately. Staining and discoloration may occur if they left on panel for a long time.
- (10) If the liquid crystal material leaks from the panel, it should be kept away from the eyes or mouth. In case of contacting with hands, legs or clothes, it must be washed away thoroughly with soap.
- (11) Protect the LCD module from static electricity, it may cause damage to the C-MOS Gate Array IC.
- (12) Do not disassemble the module.
- (13) Do not pull or fold the lamp wire.
- (14) Pins of I/F connector should not be touched directly with bare hands.

7.2 Storage Precautions

- (1) High temperature or humidity may reduce the performance of LCD module. Please store LCD module within the specified storage conditions.
- (2) If possible store them in a dark place. Do not expose the module to sunlight or fluorescent light. Keep the temperature between 5°C and 35°C at normal humidity.
- (3) It is dangerous that moisture come into or contacted the LCD module, because the moisture may damage LCD module when it is operating.
- (4) The polarizer surface should not come in contact with any other object. It is recommended that they be stored in the container in which they were shipped.

7.3 Operation Precautions

- (1) Do not pull the I/F connector in or out while the LCD module is operating.
- (2) Always follow the correct power on/off sequence when LCD module is connecting and operating. This can prevent the CMOS LSI chips from damage during latch-up.
- (3) Response time depends on the temperature. (In lower temperature, it becomes longer.)
- (4) Brightness depends on the temperature. (In lower temperature, it becomes lower.)
- (5) Be careful for condensation at sudden temperature change. Condensation makes damage to polarizer or electrical contacted parts. And after fading condensation, smear or spot will occur.
- (6) Module has high frequency circuits. Sufficient suppression to the electromagnetic interference shall be done by system manufacturers. Grounding and shielding methods are very important to minimize the interference.
- (7) Please do not give any mechanical and/or acoustical impact to module. Otherwise, module can't be operated its full characteristics perfectly.
- (8) Since a module is composed of electronic circuits, it is not strong to electrostatic discharge. Make certain that treatment persons are connected to ground through wrist band etc. And don't touch interface pin directly.
- (9) Do not display the fixed pattern for a long time because it may cause image sticking.
- (10) In order to prevent image sticking, periodical power-off or screen save is needed after fixed pattern long time display.
- (11) Black image or moving image is strongly recommended as a screen save.
- (12) Static information display recommended to use with moving image. Cycling display between 10 minutes' information (static) display and 10 seconds' moving image.
- (13) Background and character (image) color change is recommended. Use different colors for background and character, respectively. And change colors themselves periodically.
- (14) LCD system is required to place in well-ventilated environment. Adapting active cooling system is highly recommended.
- (15) Product reliability and functions are only guaranteed when the product is used under right operation usages.
- (16) If product will be used in extreme conditions, such as high temperature/ humidity, shock and vibration it is strongly recommended to contact LiteMax for filed application engineering advice. Otherwise, its reliability and function may not be guaranteed. Extreme conditions are commonly found at airports, transit stations, taxi-top, in vehicle and controlling systems.

8 Disclaimer

All information in this document are subject to change, please constant LiteMax for any new design.